

BRISTAN

Installation Instructions

Frenzy Tap Range

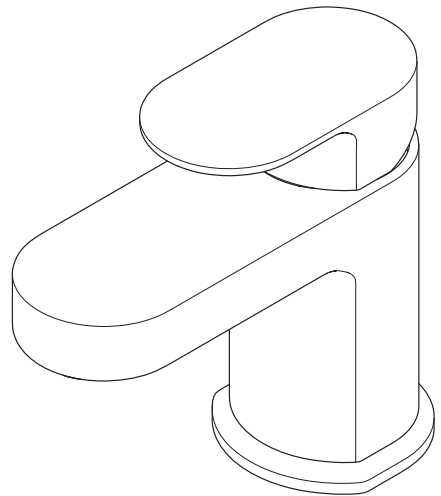

Models covered:

FRZ BAS C, FRZ 1/2 C, FRZ 3/4 C,
FRZ BF C, FRZ BSM C

Please keep this booklet for future reference.

Installer, when you have read these instructions please ensure you leave them with the user.



Contents

Thank you for choosing Bristan, the UK's leading taps and showers expert.

We have designed this product with your enjoyment in mind. To ensure that it works to its full potential, it needs to be fitted correctly. These fitting instructions have been created to give you all of the information you need and, if you need any further help, please do not hesitate to contact us.

Important Safety Information	3
General Information	4
Specifications	5
Dimensions	6-8
Installation Requirements	9
Installation	10-12
BAS	10
1/2 & 3/4	11
BF & BSM	12
Operation	13
Maintenance	14-15
Troubleshooting	16
Notes	17
Guarantee	18-19

Important Safety Information

- Please read these instructions thoroughly and retain for future use.
- All products manufactured and supplied by Bristan are safe provided they are installed, used correctly and receive regular maintenance in accordance with these instructions.
- If you are in any doubt about your ability to install this product safely you must employ the services of an experienced qualified plumber.
- This fitting needs to be installed in accordance with, and meet the requirements of the Water Supply (Water Fittings) Regulations 1999 and Scottish Byelaws 2004.
-  Remove all packaging and check the fitting for damage before starting installation.
- **Warning:** Before starting any installation please consider the following: before drilling into walls, check that there are no hidden electrical wires, cables or water supply pipes. This can be checked with the aid of an electronic detector.
- If power tools are used do not forget to: - Wear eye protection
- Unplug equipment after use
-  **Important:** Remember to turn off the mains water supply before connecting to any existing pipe work. Fitting isolating valves to the inlet feeds is recommended for ease of maintenance.
- **Warning:** Before installing the new fitting it is essential that you thoroughly flush through the pipework in order to remove any remaining swarf, solder, etc.
Failure to carry out this procedure could cause problems or damage to the workings of the fitting.
- Take care when handling the 'flexible connecting pipes', do not bend, twist or crush them. Only tighten the pipes by hand.
- This product must not be modified in any way as this will invalidate the guarantee.

General Information

This product has been tested to the Water Regulations Advisory Scheme (WRAS) and satisfies the requirements of the Water Supply (Water Fittings Regulations 1999 and current bylaws.

For full Installation Requirements & Notes (IRN) please visit:
www.wras.co.uk/directory

Designed to comply with BS EN 200 for combination taps to be used within systems designed to BS 8558.

BS 8558 recommends hot water should be stored and distributed at a temperature of not less than 60°C which will minimise the build up of limescale in hard water areas.

If the fitting is installed at low pressure (tank fed), then the minimum distance from the highest installed position of the outlet to the underside of the cold tank should be at least 2 meters to ensure adequate performance, please note FRZ BAS C, FRZ 3/4 C and FRZ BSM C requires 3 meters if installed on a low pressure system.

This tap should be installed in compliance with the Water Regulations. Where the supplies are unbalanced, i.e. hot water from cylinder tank/cold from the mains, approved check valves must be fitted in the supply pipes.

For further details, contact your Local Water Authority.

Specifications

Product Code	Working pressure		Inlet
	Min	Max	
FRZ BAS C	0.3	5.0	M10 1/2" BSP Flexible Tail
FRZ 1/2 C	0.2	5.0	1/2" BSP Threaded Tail
FRZ 3/4 C	0.3	5.0	3/4" BSP Threaded Tail
FRZ BF C	0.2	5.0	3/4" BSP Threaded Tail
FRZ BSM C	0.3	5.0	3/4" BSP Threaded Tail

Maximum static pressure – 10.0 bar

System Requirements:

Gravity fed hot & cold (Equal pressures)

Gravity fed hot & cold (Differential pressure, maximum ratio 5:1)

Unvented systems

Instantaneous water heater (Combination boiler)

Dimensions

FRZ BAS C

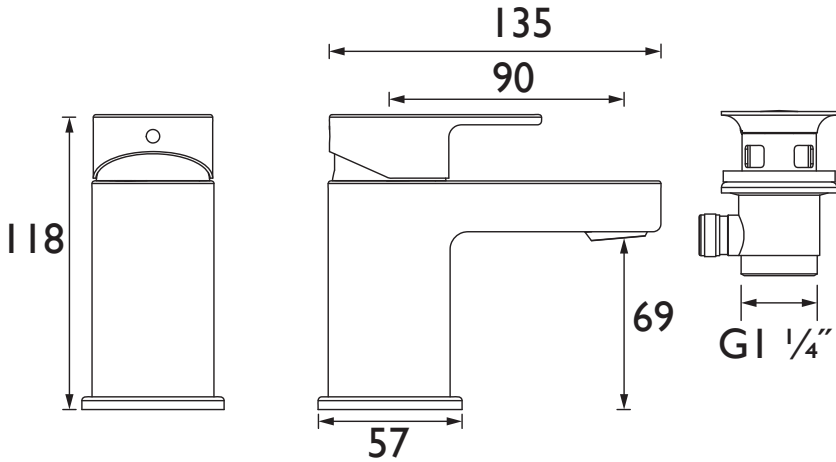

FRZ 1/2 C

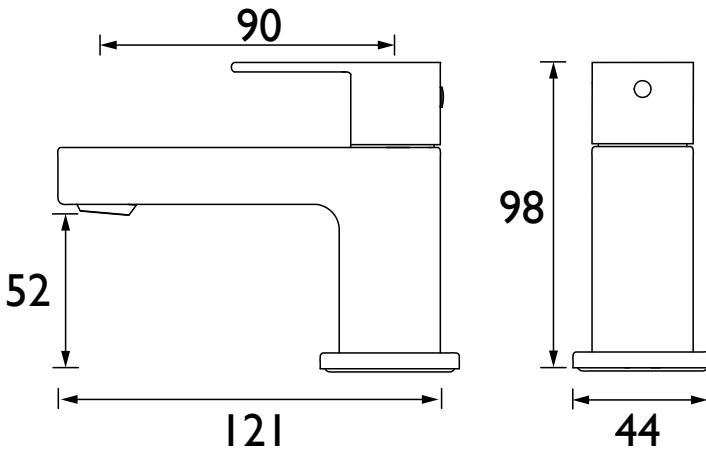

Dimensions are nominal and in millimetres.

6 **Need help?** Give us a call on 0330 026 6273 and speak to one of our trained advisers.

Dimensions

FRZ 3/4 C

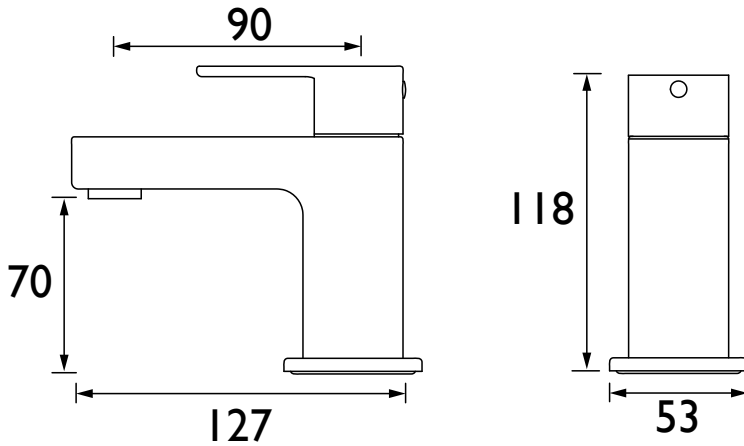

FRZ BSM C

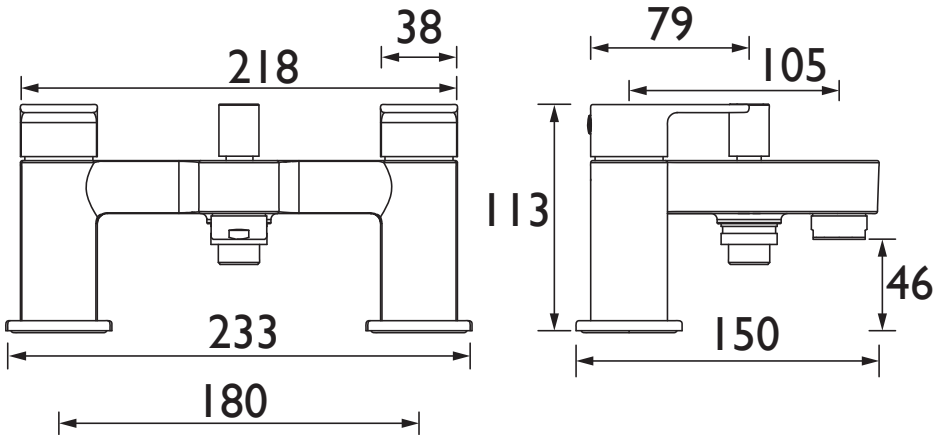

Dimensions are nominal and in millimetres.

Need help? Give us a call on 0330 026 6273 and speak to one of our trained advisers. 7

Dimensions

FRZ BF C

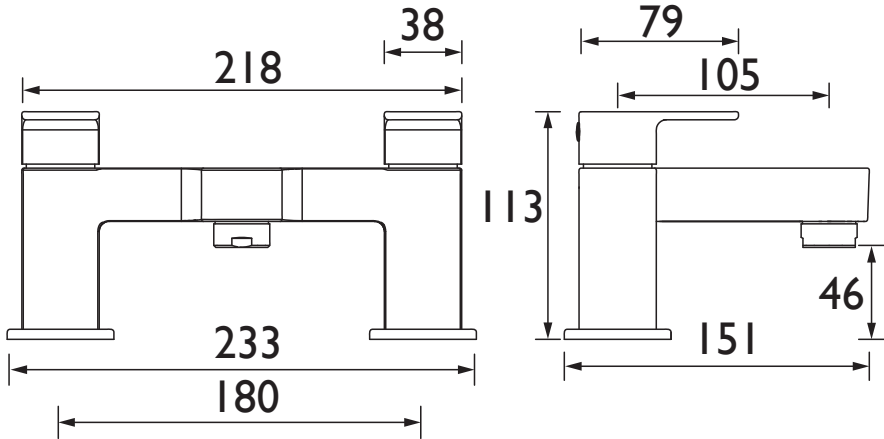

Dimensions are nominal and in millimetres.

Installation Requirements

Flexible Connecting Pipes

Care must be taken when connecting the flexible connection pipes to the household pipework to ensure they do not bend sharply and kink or twist.

See below for recommended ways to fit the flexible connecting pipes.

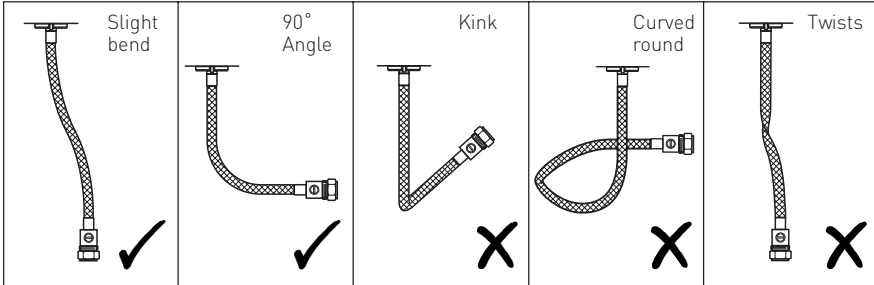

⚠ Important: Failure to follow these guidelines may result in poor performance and damage to the flexible connecting pipes.

⚠ Important: Full access must be made available on installation for future maintenance/servicing purposes.

Installation- BAS

1

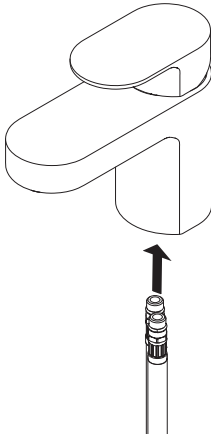

Screw the flexi tails into the bottom of the mixer body by **hand only (DO NOT OVERTIGHTEN)**

2

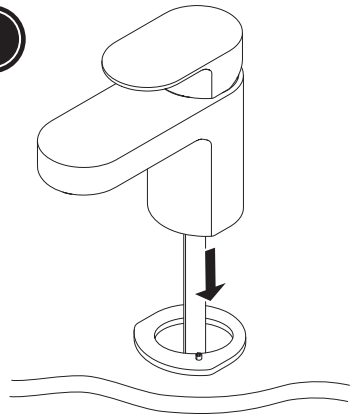

Place the plinth over the hole in the basin ensuring that the washer is fitted between the plinth and the basin. Feed the flexi tails through the hole in the basin.

3

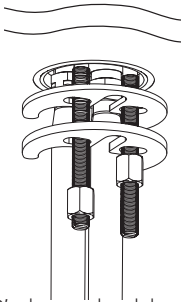

Slide the 'C' shaped rubber washer and the 'C' shaped metal washer onto the fixing rods up to the underside of the basin. To secure the mixer in place, tighten the fixing nuts onto the fixing rod until they are fully tightened against the 'C' shaped metal washer. A suitable spanner can be used to fully tighten the fixing nuts.

4

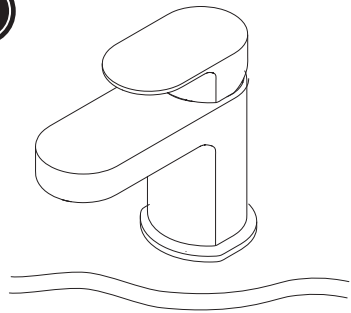

Connect the flexi tails to the hot and cold water supplies. Turn on the mains water supply letting the water flow for a few minutes to flush through the system. Check all joints and connections for any leaks.

Installation- 1/2 & 3/4

1

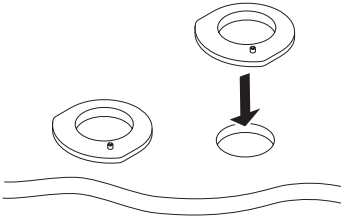

Place the plinths over the holes in the basin/ bath ensuring that the washers are fitted between the plinths and the basin/ bath.

2

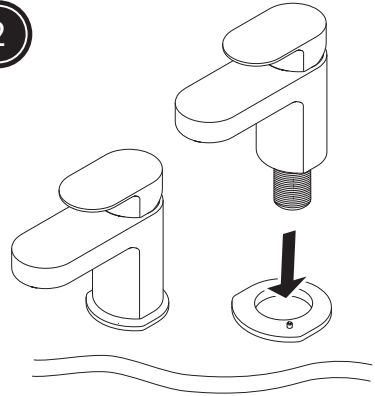

Feed the tap bodies through the holes in a basin/ bath.

3

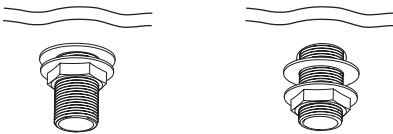

Secure the tap bodies to the basin/ bath by using the washer and metal backnut below the basin /bath. Tighten the backnut onto the threaded tails. A suitable spanner may be required to fully tighten the backnut.

4

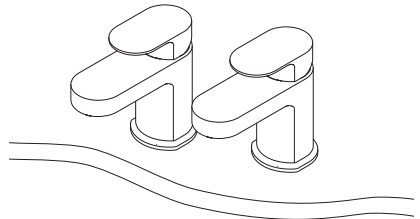

Connect the hot and cold water supplies to the threaded tails using either a 1/2" or 3/4" BSP connector (not supplied). Turn on the mains water supply letting the water flow for a few minutes to flush through the system. Check all joints and connections for any leaks.

Installation- BF & BSM

1

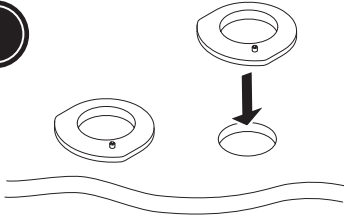

Place the plinths over the holes in the bath ensuring that the washers are fitted between the plinths and the bath.

2

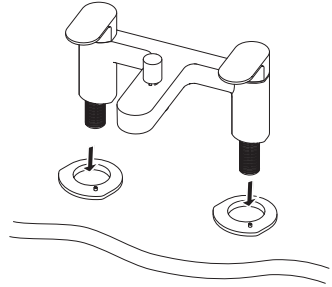

Fit the body to the bath.

3

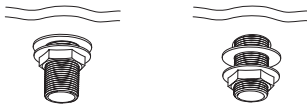

Secure the body to the bath by using the washer and metal backnut below the bath. Tighten the backnut onto the threaded tails. A suitable spanner may be required to fully tighten the backnut.

4

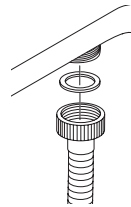

Bath Shower Mixer only - fit the shower hose to the hose outlet using the small sealing washer, and the handset to the hose using the small washer.

5

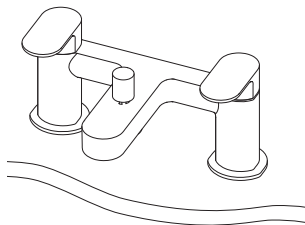

Connect the hot and cold water supplies to the threaded tails using $\frac{3}{4}$ " BSP connector (not supplied). Turn on the mains water supply letting the water flow for a few minutes to flush through the system. Check all joints and connections for any leaks.

Operation

Temperature Control

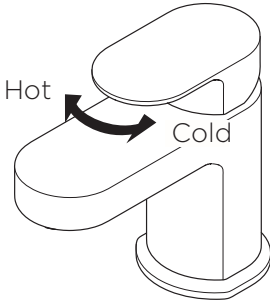

Flow Control

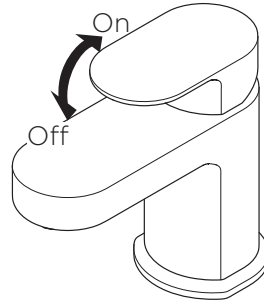

BAS

Flow Control

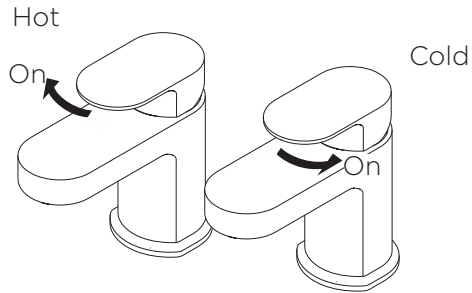

1/2 & 3/4

Flow Control

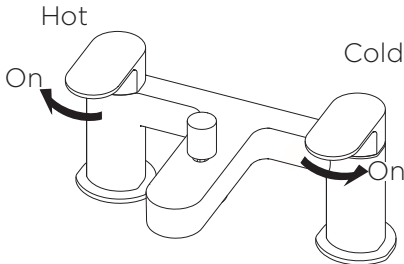

Diverter Operation

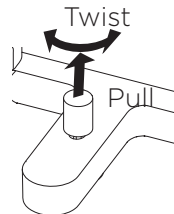

BF & BSM

Maintenance

General Cleaning

Your fitting has a high quality finish and should be treated with care to preserve the visible surfaces. All surfaces will wear if not cleaned correctly, the only safe way to clean your mixer is to wipe with a soft damp cloth. Stains can be removed using washing up liquid. All bath cleaning powders and liquids will damage the surface of your fitting, even the non-scratch cleaners.

Note: Never use abrasive detergents or disinfectants or those containing alcohol, hydrochloric acid or phosphoric acid.

Cleaning the Cartridge

Before carrying out any maintenance, turn off the mains water supply and close any isolating valves.

Prise out the cap, loosen the grub screw. Remove the handle and shroud. Remove the cartridge retaining nut using suitable spanner.

Remove the cartridge and clean thoroughly under cold water to remove any build up of limescale or debris.

If necessary replace the cartridge using parts supplied by Bristan only.

Replace the cartridge into the body, tighten the cartridge retaining nut using suitable spanner. Replace the shroud and handle. Tighten the grub screw and push fit the cap.

Using the correct size spanner remove the valve. Wash the valve with clean running water and make sure that any debris has been removed. Dry and lightly grease the seal (only use silicone grease), replace the valve shroud / shroud insert and handle tightening the grub screw.

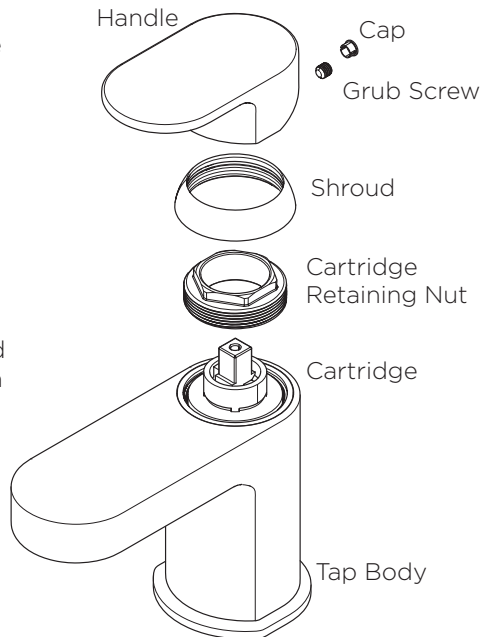

Maintenance

Cleaning the Valve

Before carrying out any maintenance, turn off the mains water supply and close any isolating valves.

Prise out the cap, loosen the grub screw and remove the spline adaptor and the handle.

Using the correct size spanner remove the valve. Wash the valve with clean running water and make sure that any debris has been removed. Dry and lightly grease the seal (only use silicone grease).

If necessary replace the valve using parts supplied by Bristan only.

Replace the valve into the body and tighten fully using the correct size spanner. Replace the spline adaptor and the handle. Tighten the grub screw and push fit the

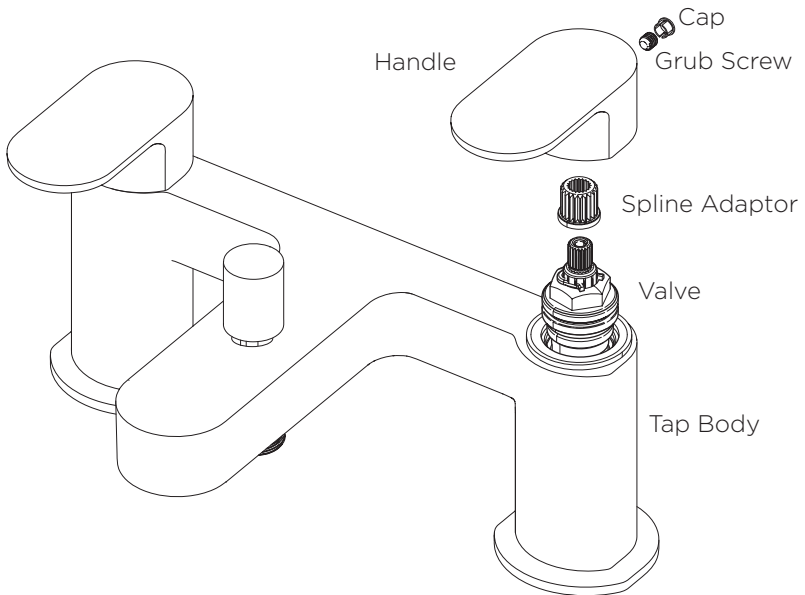

Troubleshooting

Symptom	Cause	Remedy
No flow or low flow rate	Partially closed isolation valve.	Open isolation valve.
	Instantaneous water heater cycles on and off as flow rate or pressure is too low.	Increase water flow rate or pressure through system to meet required minimum working pressure of tap.
	Head of water is below the minimum distance required.	Refer to 'Specifications' on page 5.
	Hot or cold water being drawn off elsewhere causing pressure changes or instantaneous boiler temperature changes.	Do not use other water outlets when using the taps.
	Airlock or partial blockage in the supply pipework.	Flush through pipework to ensure removal of debris and any airlocks.
Water dripping from taps	This is normal for a short time after using the taps.	This is caused by capillary action, the build up of water in the tap body.
	If water continues to drip, possible build up of debris/ limescale in the cartridge/ valve	Remove and clean the cartridge, refer to 'Maintenance' section on page 14-15 before removing the cartridge/ valve
Taps do not turn on	Closed isolation valve.	Open isolation valve.
	Mains water supply turned off.	Turn on mains water supply.

Guarantee

At Bristan, we want to make things as easy as possible for our customers. That's why we offer solid guarantees on all of our products, effective from the date of purchase, to give you peace of mind.

To start your free guarantee, simply scan the QR code and register your product. Alternatively, visit www.bristan.com/register.

For any other queries, please call our Customer Service on 0330 026 6273 where our expert team of advisors will be able to offer you any help and advice.

For full guarantee terms and conditions, visit:
www.bristan.com/guarantees

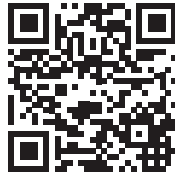

We Know & We Care

Notes

Please use this space to add any notes you or your installer may have regarding the plumbing system / installation of this product.

Notes

Please use this space to add any notes you or your installer may have regarding the plumbing system / installation of this product.

Part Numbers: **FRZ TAPS**

Issue: D3

BRISTAN

Bristan Group Ltd.
Birch Coppice Business Park
Dordon
Tamworth
Staffordshire
B78 1SG
Web: www.bristan.com
Email: enquire@bristan.com

A Masco Company

Useful contact details:

Customer Service:

0330 026 6273

Customer Service Email:

Customercare@bristan.com

Join us on...

