

9.5 kW

mira

Play

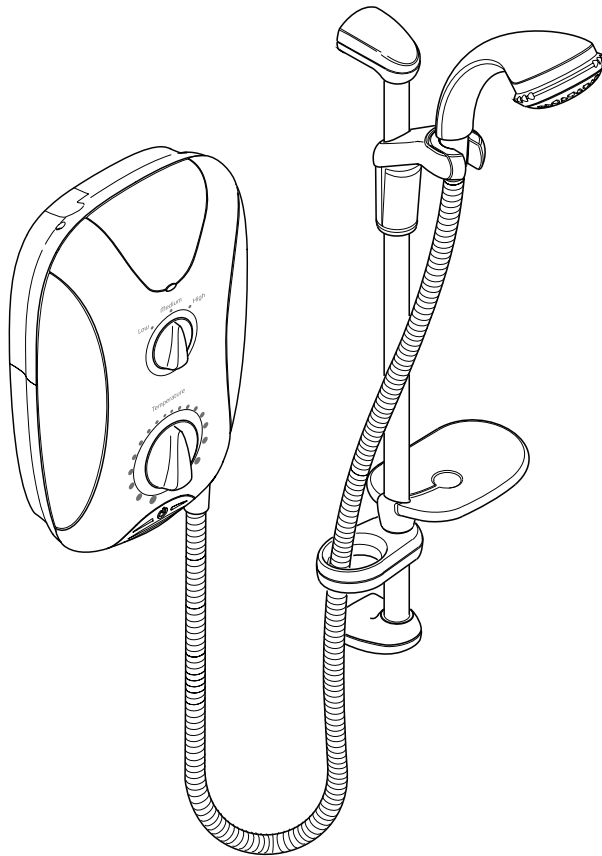

ELECTRIC SHOWER

Installation & User Guide

THESE INSTRUCTIONS ARE TO BE LEFT WITH THE USER

Contents

Section	Page
Introduction	3
Important Safety Information	4
Pack Contents Checklist	6
Specifications	7
Installer Instructions	8
Installation	12
Commissioning	16
User Instructions	18
Fault Diagnosis	23
Maintenance	28
Dimensions	30
Wiring Diagram	31
Accessories - Mira DCV-H	32
Spare Parts	32
Guarantee, Customer Care Policy, and How to contact us	Back Cover

Introduction

Thank you for purchasing a quality Mira product. To enjoy the full potential of your new product, please take time to read this guide thoroughly. Having done so, keep it handy for future reference.

The Mira Play is an electric shower with separate controls for power selection and temperature/flow adjustment. A unique flow regulator stabilizes temperature changes caused by water pressure fluctuations. These can result from taps being turned on or off, or toilets being flushed. An individual light indicates “POWER ON”.

This shower comes complete with a set of Mira Response Adjustable Shower Fittings.

Mira Play models covered by this guide:

Mira Play 9.5 kW- A 9.5 kW 240 V AC (8.3 kW 230 V AC) heater. Available in white/white panel, white/chrome panel and satin/chrome panel finishes.

Mira Shower Fittings covered by this guide:

Mira Response Adjustable Shower Fittings

An adjustable spray handset with three different spray actions (start, soothe and force), supplied complete with flexible hose, clamp bracket assembly, slide bar, supports, soap dish, and hose retaining ring. Available in white/chrome finish.

If you experience any difficulty with the installation or operation of your new shower control, then please refer to the **Fault Diagnosis** section before contacting Kohler Mira Ltd. Our telephone and fax numbers can be found on the back cover of this guide.

Important Safety Information

1.Warning!

- 1.1. Products manufactured by us are safe and without risk provided they are installed, used and maintained in good working order in accordance with our instructions and recommendations.
- 1.2. **THIS APPLIANCE MUST BE EARTHED. MAKE SURE SUPPLEMENTARY BONDING COMPLIES WITH THE “REQUIREMENTS FOR ELECTRICAL INSTALLATIONS”.**

The installation must be in accordance with the current edition of BS 7671 “The IEE Wiring Regulations” in force at the time of installation. This appliance is intended to be permanently connected to the fixed electrical wiring of the mains system with its own dedicated supply.

- 1.3. **DO NOT** twist the individual cable cores of the live and neutral conductors, as this will prevent them from entering the terminal block.
- 1.4. The shower unit must **NOT** be fitted where it may be exposed to freezing conditions. Make sure that any pipework that could become frozen is properly insulated.
- 1.5. **DO NOT** fit any form of outlet flow control as the outlet acts as a vent for the tank body. Only Mira recommended outlet fittings should be used.
- 1.6. If the cover is removed, the following warnings must be observed:
 - 1.6.1. Turn off the electrical and water supplies before removing the cover.
 - 1.6.2. Mains connections are exposed when cover is removed.
 - 1.6.3. Refer to the wiring diagram before making any electrical connections (see section “Wiring Diagram”).
 - 1.6.4. Ensure all electrical connections are tight, to prevent them overheating.

2. Caution!

- 2.1.** Follow all warnings, cautions and instructions contained in this guide, and on or inside the appliance.

- 2.2.** The electrical installation must comply with the “Requirements for Electrical Installations”, commonly referred to as BS 7671 the “IEE Wiring Regulations”. Or any particular regulations and practices, specified by the local electricity supply company in force at the time of the installation. The installation should be carried out by an electrician or contractor who is “Part P” (Building Regulations) registered, or is a member of an association such as:
 - 2.2.1.** National Inspection Council for Electrical Installation and Contracting (NICEIC), throughout the UK.
 - 2.2.2.** The Electrical Contractors Association (ECA), England and Wales.
 - 2.2.3.** The Electrical Contractors Association of Scotland (ECAS).

- 2.3.** The plumbing installation must comply with the requirements of UK Water Regulations/Bye-laws (Scotland), Building Regulations or any particular regulations and practices, specified by the local water company. The installation should be carried out by a plumber or contractor who is registered, or is a member of, an association such as:
 - 2.3.1.** Institute of Plumbing (IOP), throughout the UK.
 - 2.3.2.** National Association of Plumbing, Heating and Mechanical Services Contractors (NAPH & MSC), England and Wales.
 - 2.3.3.** Scottish and Northern Ireland Plumbing Employers’ Federation (SNIPEF), Scotland and Northern Ireland.

Pack Contents Checklist



Tick the appropriate boxes to familiarize yourself with the part names and to confirm that the parts are included.

1. Mira Play 9.5 kW

1 x Mira Play 9.5 kW

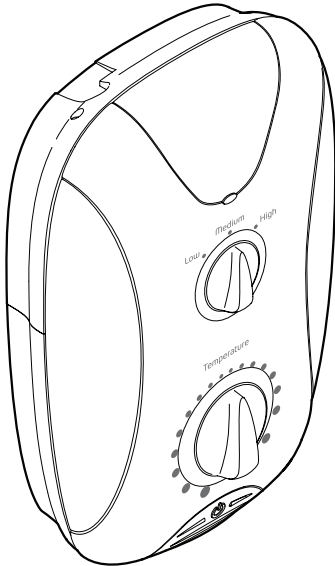

3 x Fixing Screws



3 x Wall Plugs

2. Documentation

1 x Installation and User Guide

1 x Installation Template

1 x Guarantee Card

3. Mira Response Adjustable Shower Fittings

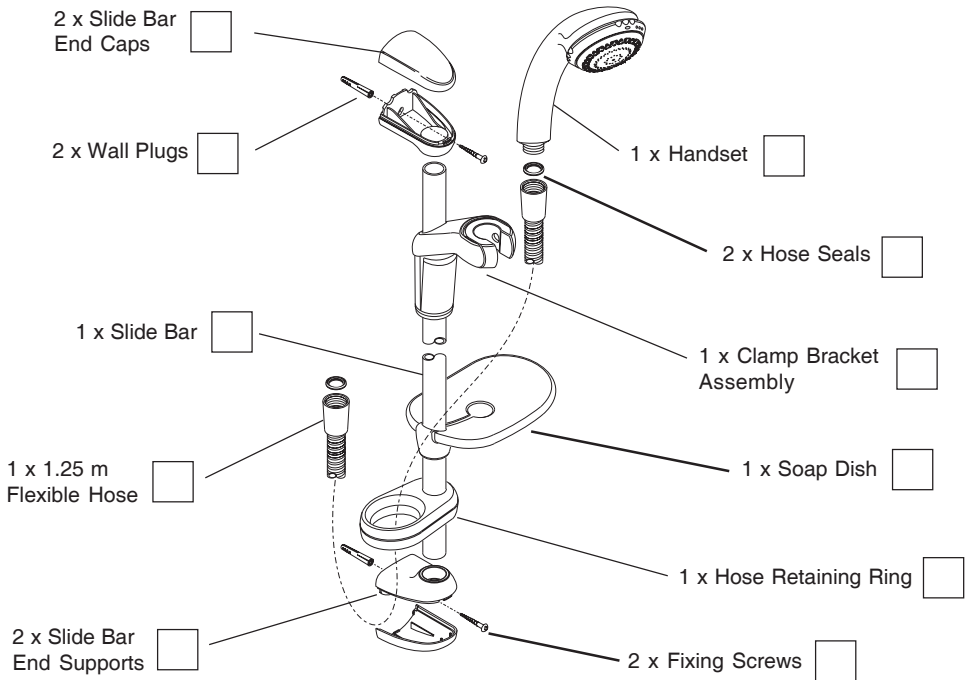

Specifications

1. Plumbing

- 1.1. Minimum maintained inlet pressure:
9.5 kW = 70 kPa (0.7 bar)
- 1.2. Maximum static inlet pressure of 1000 kPa (10 bar).
- 1.3. Minimum static inlet pressure of 50 kPa (0.5 bar) to keep the inlet valve closed.

2. Electrical

- 2.1. The Mira Play 9.5 kW requires a 40 Amp fuse.
- 2.2. The terminal block will accept cable sizes up to 16 mm².

3. Standards and Approvals

- 3.1. The Mira Play complies with all relevant directives for CE marking.

Installer Instructions

Read the section “Important Safety Information” first.

Plumbing Checklist

1. Minimum maintained inlet pressure = 70 kPa (0.7 bar).
Maximum static inlet pressure = 1000 kPa (10 bar).
2. Water treatment device (if required).
3. Free flowing isolating valve.
4. Positioned over water catchment area.
5. Fitted to finished wall surface.
6. No sharp hose kinks.
7. Fittings positioned with greater than 25 mm gap or outlet double checkvalve fitted.
8. Supply pipework flushed clear.
9. Watertight inlet connection and fittings.
10. Cover secured correctly.

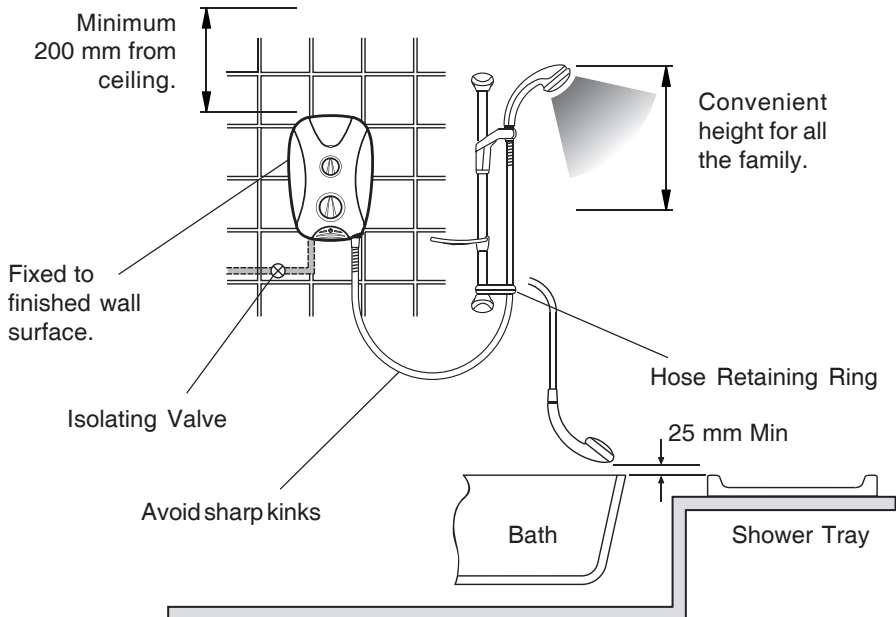

Plumbing (checklist in detail)

1. The appliance is designed to operate with a **minimum maintained inlet pressure of 70 kPa (0.7 bar)**, up to a **maximum static inlet pressure of 1000 kPa (10 bar)**.
2. When installed in very hard water areas (above 200 ppm temporary hardness) your installer may advise the installation of a water treatment device, to reduce the effects of limescale formation. Your local water company will be able to advise the hardness of water in your area.
3. It is recommended that a non-restrictive (free flowing) isolating valve is fitted as part of the cold water supply pipe to allow the complete maintenance of the appliance. Do not use a valve with a loose washer plate (jumper) as this can lead to the build up of static pressure.
4. The appliance is only suitable for installation within the shower area. It is fitted with a pressure relief device and must be positioned over a water catchment area with the controls at a convenient height for all users.
5. The appliance must be fitted onto a finished flat and even wall surface (this wall surface should be tiled or suitably waterproofed). Do not fit the appliance to the wall and tile up to the case. For safety requirements, an air gap must be left behind the appliance.
6. Avoid layouts where the shower hose will be sharply kinked. This may reduce the life of the hose.
7. A Hose Retaining Ring is supplied to prevent the handset from dropping below the spill-over level of the bath or shower tray, which could lead to contamination from back-siphoning. The supplied Hose Retaining Ring should meet the greater majority of user requirements for shower installations with flexible outlet fittings. However, there will be occasions where it will not provide a suitable solution. In these instances an outlet double checkvalve, e.g. a Mira DCV-H, must be fitted. This will increase the required supply pressure typically by 10 kPa (0.1 bar). See section "Accessories".
8. Supply pipework must be flushed to clear any debris before connecting to the appliance.
9. To avoid damage to the case when soldered fittings are used, pre-solder the pipework and fittings before connecting them to the inlet connector assembly. Refrain from applying excessive force when making any connections. Always provide mechanical support when making the plumbing connections.
10. The appliance is fitted with a plastic inlet compression assembly for connecting to a 15mm supply pipe from the top, bottom or back. Double checkvalves, fitted in the inlet supply to the appliance, cause a pressure build-up, which could exceed the maximum static inlet pressure and damage the appliance.

Read the section “**Important Safety Information**” first.

Electrical Checklist

1. Electrical supply fuse and consumer unit are adequate for the product.
2. Shower unit is earthed.
3. The minimum required supply cable size must conform to BS 7671.
4. Double pole isolating switch.
5. **DO NOT** twist live or neutral cable cores.
6. Electrical connections are tightly secured.
DO NOT strain the terminal block.
7. Plumbing supply completed before electricity supply is turned on.

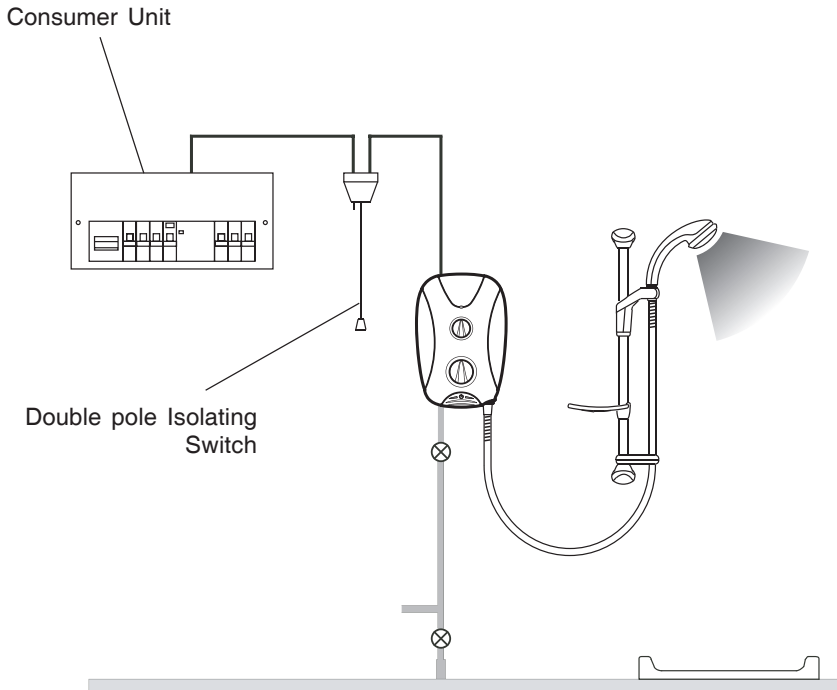

Electrical (checklist in detail)

1. In a domestic installation, the rating of the electricity supplier's fuse and the consumer unit must be adequate for the additional demand. All Mira Play electric showers are high power units, therefore it is essential to contact your electricity supplier to ensure that the supply is adequate for the product. Voltage drop due to local heavy demand will reduce the shower's performance.
2. The appliance must be earthed by connecting the supply cable's earth conductor to the earth terminal.
Supplementary bonding: Within the bathroom or shower room, all accessible conductive parts of electrical equipment and extraneous conductive parts (metal parts) that are likely to introduce earth potential, must be electrically bonded to earth. If the cable is not mechanically protected, the cable size must be a minimum of 4.0 mm² (2.5 mm² if mechanically protected). Use a suitable earth bonding strap to connect the earth terminal to 15mm copper pipe. The installation must comply with the "REQUIREMENTS FOR ELECTRICAL INSTALLATIONS" in accordance with BS 7671.
3. Supply cable - see opposite.

Important! The shower circuit should be separated from other circuits by at least twice the diameter of the cable or conduit, and it should not be run through thermally insulating material or in locations where the ambient temperature is likely to exceed 30 °C. If any of these conditions are unavoidable, it is necessary to determine the cable size which will prevent damage to the cable caused by overheating.

4. **As a guide only**, and in accordance with BS 7671 we recommend close circuit protection:
i.e. 9.5 kW = 40 Amp.

It is strongly recommended that a 30 mA Residual Current Device (RCD) is included in the electrical circuit. This may be part of the consumer unit or a separate unit. A separate, permanently connected supply is taken from the consumer unit to the appliance through a double pole isolating switch, which has at least 3 mm of contact separation. The switch can be a ceiling mounted pullcord type within the shower room, or a wall mounted switch in an adjacent room.

5. **DO NOT** twist the individual cable cores of either the live or neutral conductors, as this will prevent them from entering the terminal block.
6. **DO NOT** exert strain on the terminal block. Ensure that the electrical connections are tightly screwed down.
7. **DO NOT** turn on the electrical supply until the plumbing has been completed.

Installation

Mira Play

Read the section “Important Safety Information” first.

1.



Electrical supply is turned off at the mains.

2.

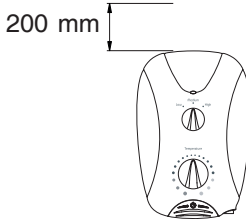

200 mm minimum gap from ceiling.

3.

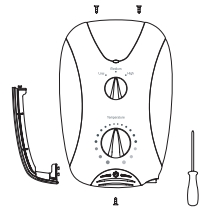

Remove three screws.

4.

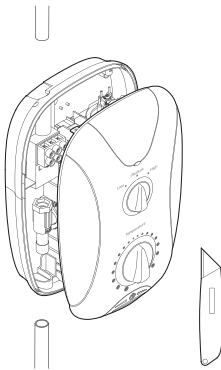

Remove Cover and determine supply pipe position.

5.

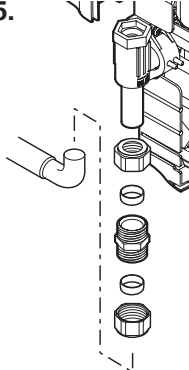

For back inlet use soldered elbow.

6.

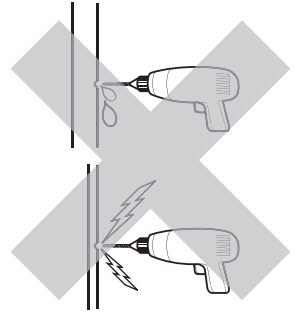

CAUTION! Do not drill into buried cables or pipes.

7.

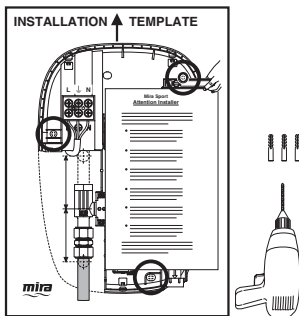

Drill and plug* the three holes using template.

8.

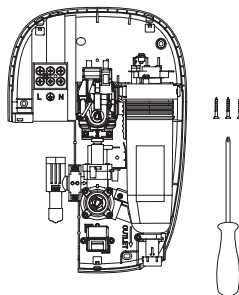

Fix appliance to wall.

9.

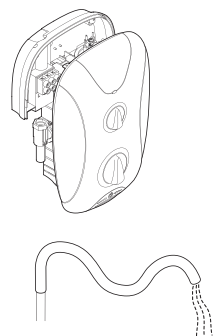

Flush a minimum of 10 litres through pipework.

* Alternative fixings for some wall structures are not supplied.

10.

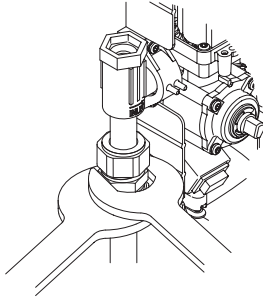

Connect supply pipe.
Do not overtighten!

11.

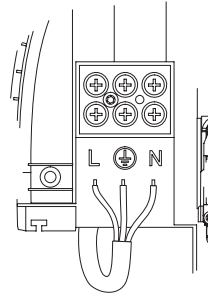

Feed cable into Case. Fit Earth sleeve (not supplied) and strip insulation.
Do not twist cable cores.

12.

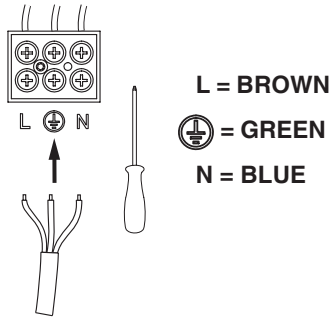

Firmly connect the conductors. **Do not** exert strain on the terminal block.

13.

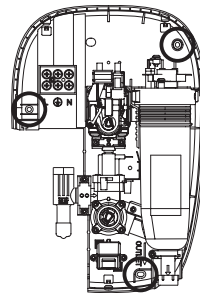

Make sure wires are clear of all mounting holes.

14.

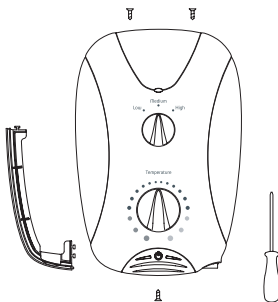

Refit the Service Tunnel and Cover. Make sure they fit correctly.
Do not overtighten screws.

15.

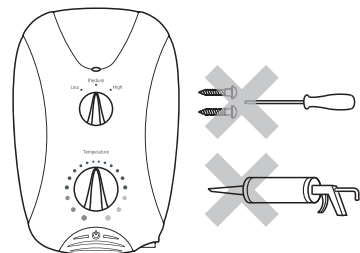

Do not use alternative screws to secure the Cover. This can cause internal damage to the appliance.
Do not seal around the back of appliance.

Mira Response Adjustable Shower Fittings

Read the section “Important Safety Information” first.

1.

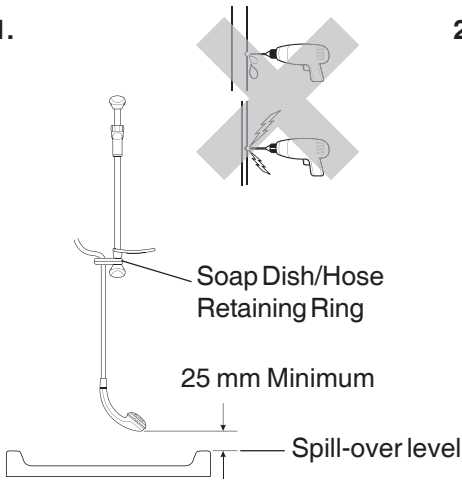

Position as shown to prevent back siphoning.

2.

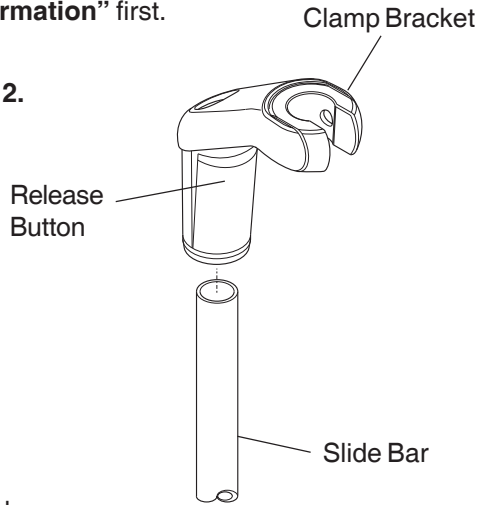

Depress release button **FULLY** and assemble Clamp Bracket. Release the button when in desired position.

3.

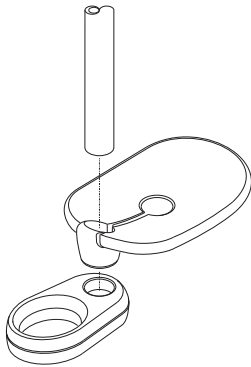

Slide the Soap Dish and the Hose Retaining Ring onto the Slide Bar below the Clamp Bracket.

4.

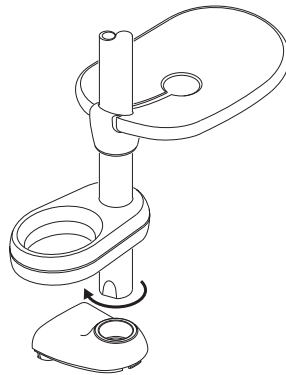

Fit both the top and bottom Supports. Make sure the slots are aligned to fit fully home.

5.

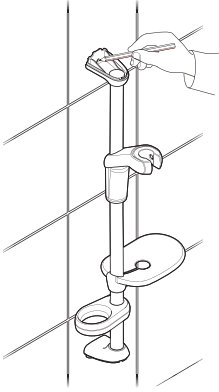

Mark the positions of the slots on both top and bottom Supports.

6.

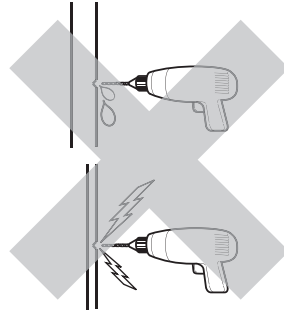

CAUTION! Do not drill into buried cables or pipes.

7.

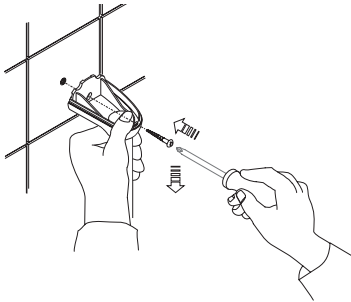

First fix bottom Slide Bar Support and fully tighten the screw*. Then fix the top Slide Bar Support whilst pressing it down, to keep the whole assembly together.

8.

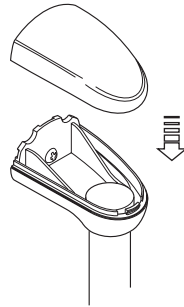

Fit the End Caps to the Slide Bar Supports.

9.

Fit the Hose to both the Handset and the Shower Outlet, remembering to pass it through the Hose Retaining Ring. **Do not** overtighten the Hose connections.

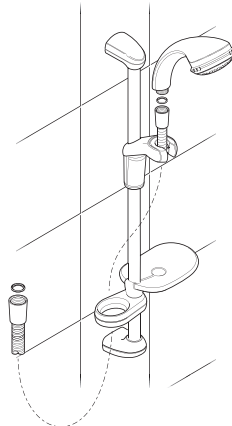

* Alternative fixings for some wall structures are not supplied.

Commissioning

If you are unsure how an electric shower works, please read through the section “**User Instructions**” before continuing.

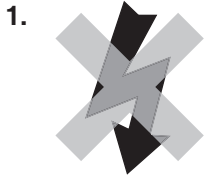

1. Electrical supply is turned off at the mains.

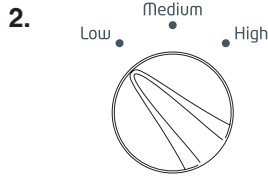

2. Set control to **LOW**.

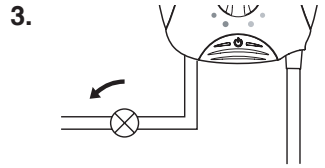

3. Turn water supply fully on.

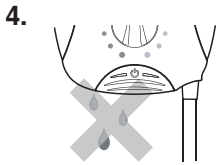

4. Check for water leaks.

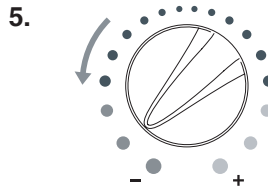

5. Turn control to full cold.

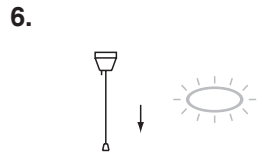

6. Switch on electrical supply.

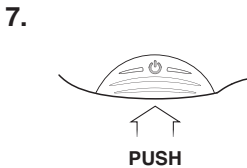

7. Push **START** button.

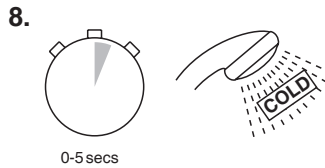

8. Water will be flowing at a cool temperature.

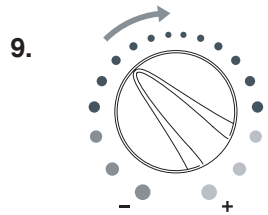

9. Turn control slowly. Temperature remains cool and flow is reduced.

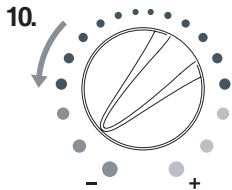

10. Turn control to full cold.

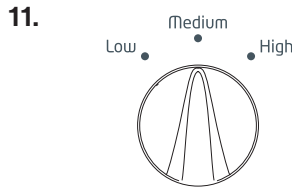

11. Set control to **MEDIUM**.

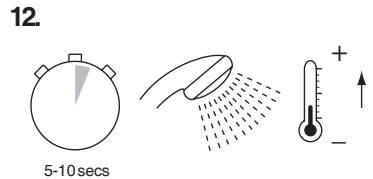

12. The temperature will rise slightly.

13.

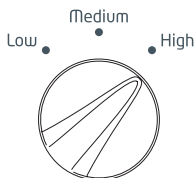

Set control to HIGH.

14.



The temperature will rise further.

15.

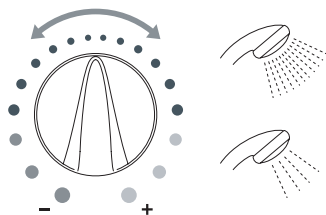

Adjust temperatures as required.
Flow rate will adjust automatically.

16.

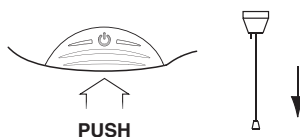

Press STOP and isolate power.

17.

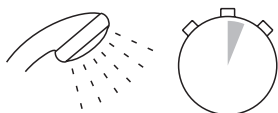

The shower will purge water
from its tank for a few seconds.

18.



Residual water may drain
over a few minutes.

Note! A slight “hissing” sound may be heard from the appliance during operation. High mains water pressure and high shower temperature will affect the tone. This is quite normal in use.

User Instructions

1. Warning!

- 1.1. **DO NOT** operate this appliance if it appears to be frozen. Allow the appliance to thaw and then contact your installer before using again.
- 1.2. **DO NOT** operate this appliance if water leaks from the pressure relief valve; maintenance will be required before the appliance can be safely used.
- 1.3. There are no user serviceable components beneath the cover of this appliance. Only a competent tradesperson should remove the Cover.
- 1.4. If any of the following conditions occur, isolate the electricity and water supplies. Contact your installer or refer to “To contact us”, on the back page of this guide.
 - 1.4.1. If water is leaking from inside the product.
 - 1.4.2. If the case is damaged.
 - 1.4.3. If the appliance begins to make an odd noise, smell or smoke.
 - 1.4.4. If the appliance shows signs of a distinct change in performance, indicating a need for maintenance.
 - 1.4.5. If the cover is not correctly fitted.

2. Caution!

- 2.1. Read all of these instructions and retain this guide for later use.
- 2.2. Pass on this guide in the event of change of ownership of the installation site.
- 2.3. Anyone who may have difficulty understanding or operating the controls of any shower should be attended whilst showering. Particular consideration should be given to the young, the elderly, the infirm, or anyone inexperienced in the correct operation of the controls.
- 2.4. When this appliance has reached the end of its serviceable life, it should be disposed of in a safe manner, in accordance with current local authority recycling or waste disposal policy.

How Your Electric Shower Works

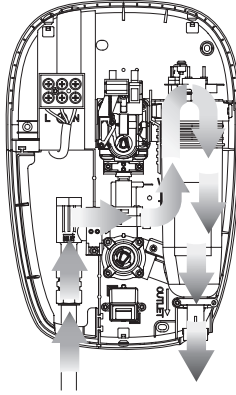

Hot water is produced by passing cold water through a heating tank.

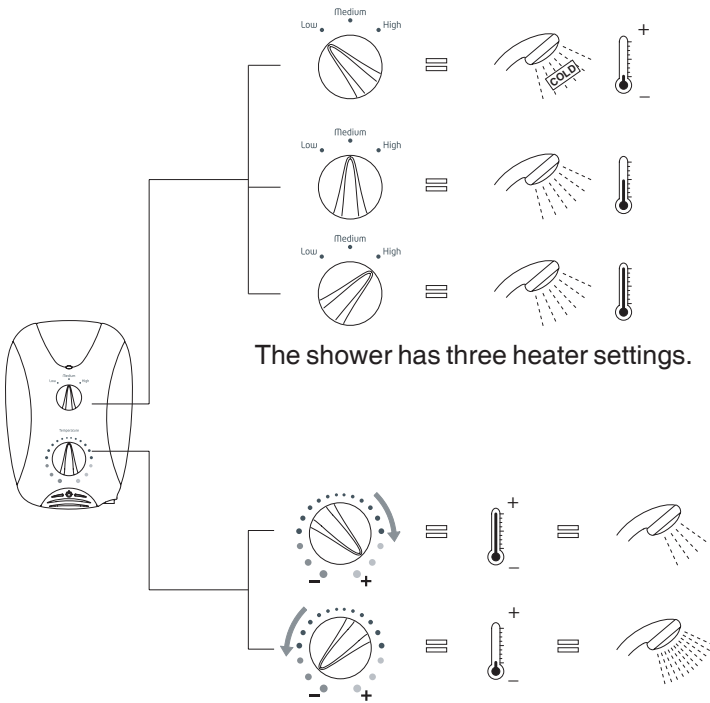

The warmer the shower, the lower the flow rate and vice versa.

The Effect of Seasonal Changes

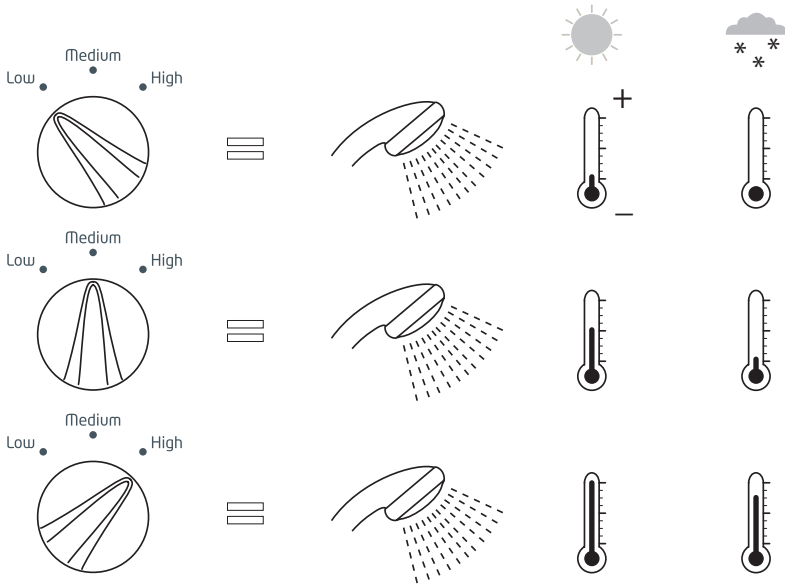

For a cold shower select Low.
 For a summer warm shower select Medium.
 For a winter warm shower select High.
 During extremes of mains water supply temperature, adjust heater setting to obtain a better showering temperature.

The Effect of Other Water Devices

Example of how shower temperature stabilizes due to sudden pressure changes.

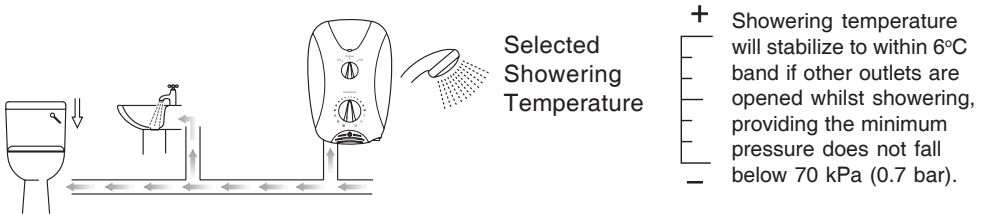

Water inlet pressure fluctuations due to other draw offs (e.g. flushing toilet) will cause the showering temperature to increase.

Using Your Shower

Read the section “Important Safety Information” first.

1.

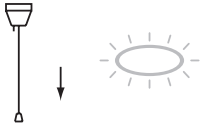

Switch on electrical supply.

2.

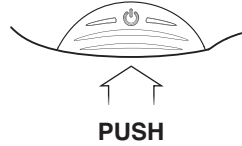

Press START button.

3.

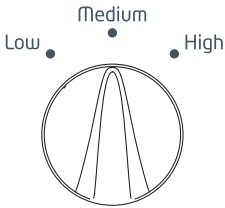

Set to desired position.

4.



Check water temperature before entering shower.

5.

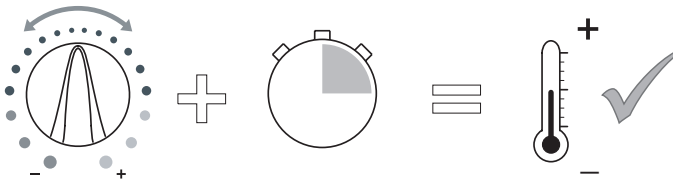

Allow 10-15 seconds for any temperature adjustments to reach the handset.

6.

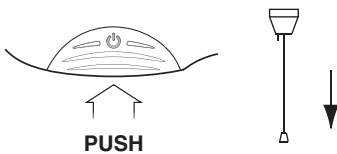

Press STOP button.
Shower will continue to run for a few seconds before stopping.

7.



A small amount of water may continue to drain over a few minutes.

Changing the Spray Setting

The handset has three different spray settings (Start, Soothe and Force).

1.

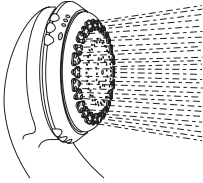

Start

Turn the Spray Plate anticlockwise until it “clicks”. Water will flow from the outer set of holes.

2.

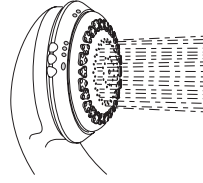

Soothe

Turn the Spray Plate anticlockwise until it “clicks”. Water will flow from the large diameter holes.

3.

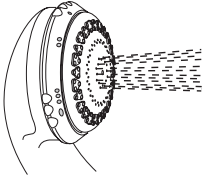

Force

Turn the Spray Plate anticlockwise until it “clicks”. Water will flow from the inner set of holes.

Adjusting the Clamp Bracket

1.

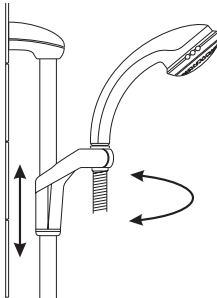

Depress the release button and slide the Clamp Bracket assembly to the required position.

2.

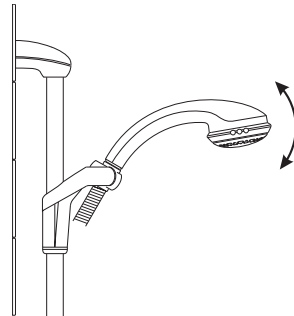

Move the Handset to the required angle.

Fault Diagnosis

The trouble shooting information table below gives details on probable causes and remedies should difficulties be encountered whilst the shower is in operation.

Warning! There are no user serviceable components beneath the cover of the appliance.

ONLY A COMPETENT TRADESPERSON SHOULD REMOVE THE FRONT COVER!

Symptom	Power Light	Heater Setting Low/ Medium/ High	Probable Cause	Possible Remedy
<i>Shower is too hot during the summer.</i>	ON	High	The incoming water is warmer in the summer, so the shower heater setting is too high.	Turn the Heater Control to Medium and adjust the Temperature Control until the desired temperature is achieved.
<i>Shower is too hot.</i>	ON	Medium/ High	Handset blocked.	Remove and clean.
<i>Turning the temperature control does not affect the water temperature.</i>	ON	Medium/ High	Handset blocked.	Remove and clean. If fault persists, contact the shower installer.
<i>The water continues to flow when the double pole switch is turned off.</i>	OFF	Any	The diaphragm is damaged.	Contact shower installer to replace the flow valve assembly.
<i>No water or very low flow rate.</i>	OFF	Any	The power is off at the double pole switch.	Switch on the power at the double pole switch. (Continued...)

Symptom	Power Light	Heater Setting Low/ Medium/ High	Probable Cause	Possible Remedy
	ON	Any	The incoming water supply stop valves, or the appliance isolating valve, is closed.	Open the stop/isolating valve fully.
	ON	Any	Handset blocked.	Remove and clean. For sprayplate cleaning, refer to the Handset manual.
	OFF	Any	The fuse is blown or the MCB/RCD has been tripped, indicating a possible electrical fault.	Renew the fuse or reset the MCB/RCD. If the fault persists, contact the shower installer.
<i>No hot water from shower, with the controls in any position.</i>	ON	Medium/ High	Other water outlets are being used during showering, causing the water pressure to drop below the minimum requirement.	Ensure the other water outlets, such as a washing machine or dishwasher, are not in use during showering.
	ON	Medium/ High	The water pressure is below the minimum required.	Make sure that the incoming water supply isolating valve(s) are completely open. If the fault persists, contact the shower installer.
<i>Shower temperature cycles between hot and cold.</i>	ON	Medium/ High	The temperature is set too high. This is causing the Thermal Switch to turn off the Heating Element to reduce the water temperature.	Turn the Temperature Control anticlockwise to reduce the water temperature.

(Continued...)

Symptom	Power Light	Heater Setting Low/ Medium/ High	Probable Cause	Possible Remedy
	ON	Medium/ High	The temperature is set too high. This is causing the Thermal Switch to turn off the Heating Element to reduce the water temperature.	Turn the Temperature Control anticlockwise to reduce the water temperature. DO NOT TAMPER with the Thermal Switch.
ALL OF THE FOLLOWING REMEDIES MUST ONLY BE PERFORMED BY A COMPETENT TRADESPERSON!				
<i>No hot water from the shower, with controls in any position.</i>	ON	Medium/ High	Insufficient mains water pressure.	Contact local water company.
	ON	Medium/ High	Failure of the pressure switch, microswitch or thermal switch.	Check the continuity of the switches, using a suitable continuity measuring device. Replace the switches as necessary.
	ON	Medium/ High	Internal wiring connection failed.	Check the integrity of the internal wiring.
	ON	Medium/ High	One of the Heater Tank elements has failed.	Replace the Heater Tank.
<i>Turning the Temperature Control does not affect the water temperature.</i>	ON	Medium/ High	Switch assembly diaphragm fault. Water dripping from the unit.	Replace switch assembly.
	ON	Medium/ High	The Flow Regulator is faulty.	Replace the Flow Regulator.
	ON	Medium/ High	The Handset is blocked.	Remove and clean. If fault persists, contact Customer Services.

Symptom	Power Light	Heater Setting Low/Medium/High	Probable Cause	Possible Remedy
<i>No water, or very low flow rate.</i>	ON	Any	Handset blocked.	Remove and clean.
	ON	Any	The incoming water supply stop valves, or the appliance isolating valve, is closed.	Open the stop/isolating valve fully.
	ON	Any	Insufficient mains water pressure.	Check the integrity of the internal wiring.
	ON	Any	The Heater Tank is excessively scaled.	Replace the Heater Tank.
	ON	Any	The Pilot Valve is faulty.	Replace.
	ON	Any	Inlet Filter blocked.	Clean or renew. See "Maintenance" section.
	OFF	Any	The power is off at the double pole switch.	Switch on the power at the double pole switch.
	OFF	Any	The fuse is blown or the MCB/RCD has been tripped, indicating a possible electrical fault. For example, Heater Tank element failure.	Renew the fuse or reset the MCB/RCD. Replace the Heater Tank.
<i>Water leaks from the bottom of the case near the outlet. There is no flow from the outlet.</i>	ON	Any	The Pressure Relief Valve in the Heater Tank has been triggered (this works to reduce the damage to the appliance if the outlet is blocked or the unit is frozen.	Resolve the blocked outlet. (Continued...)

Symptom	Power Light	Heater Setting Low/Medium/High	Probable Cause	Possible Remedy
			When the Relief Valve operates, a small rubber ball is ejected.	Reset the Relief Valve assembly. See "Maintenance" section.
<i>The water cannot be turned off.</i>	OFF	Any	The Pilot Valve is faulty.	Replace.
	OFF	Any	The diaphragm is damaged.	Replace the Flow Valve assembly.
	OFF	Any	The supply pressure is below the minimum requirement.	Contact local water company. Check the static water pressure. Note that the static pressure may fall below minimum requirement when other appliances are drawing water. For example, a washing machine or garden hose.

Maintenance

Handset - Cleaning



Clean with mild washing up detergent or soap solution. Wipe dry with soft cloth.



Poor shower performance can be avoided by cleaning the spray head. Use thumb or soft cloth to wipe rubber nozzles. The handset must also be descaled regularly.

Inlet Filter - Cleaning/Renewing

Read the section “Important Safety Information” first.

1.



Electrical supply is turned off at the mains.

2.

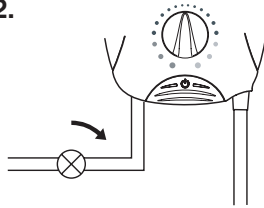

Turn water supply fully off.

3.

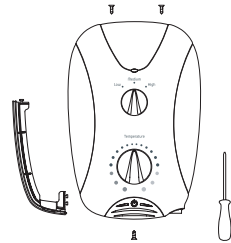

Remove three screws, Cover and Service Tunnel.

4.

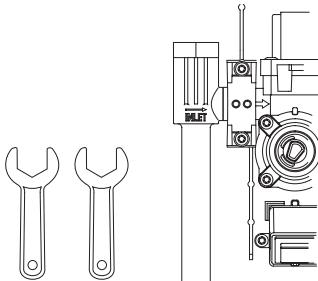

5.

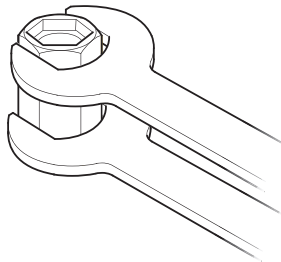

Hold a wrench across the flats of the plastic connector. Unscrew the Filter using another wrench as shown. Clean or renew the Filter as necessary. Refit in reverse order, making sure the Filter is screwed fully home.

Do not overtighten. Make sure plumbing connections are sealed before restoring electricity supply.

Relief Valve Assembly - Resetting

Read the section “Important Safety Information” first.

1.



Electrical supply is turned off at the mains.

2.

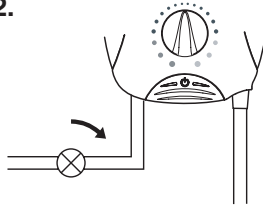

Turn water supply fully off.

3.

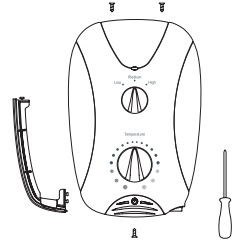

Remove three screws, Cover and Service Tunnel. Small rubber ball should be loose in the Case.

4.

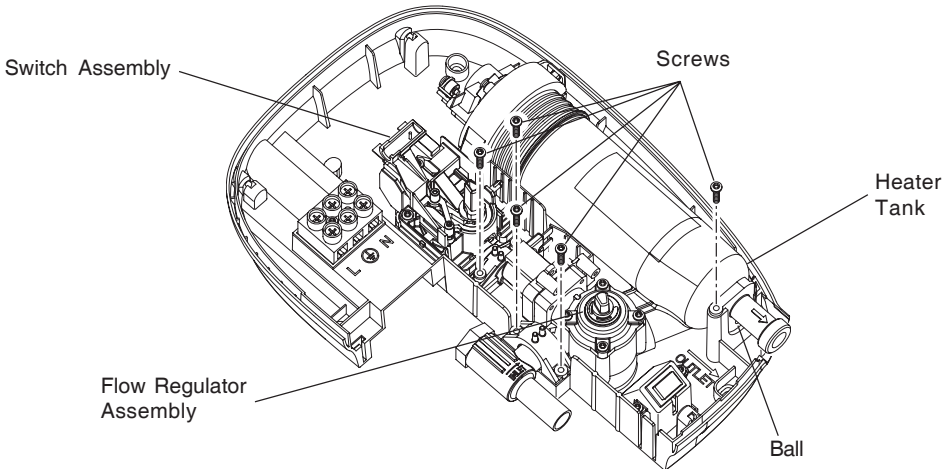

Remove the five screws and lift out the Switch, Heater Tank and Flow Regulator assemblies.

5.

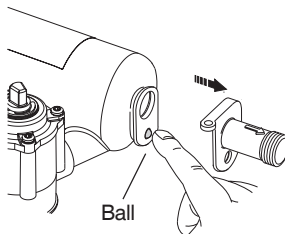

Using your finger, push the ball back into the hole in the Heater Tank assembly. **DO NOT** remove the 'O' seal.

6.

Refit the components in reverse order and replace the Cover. If the Cover does not fit easily, rotate the controls slightly so that they fit onto the Sinds beneath. **DO NOT** force the Cover to fit.

Dimensions

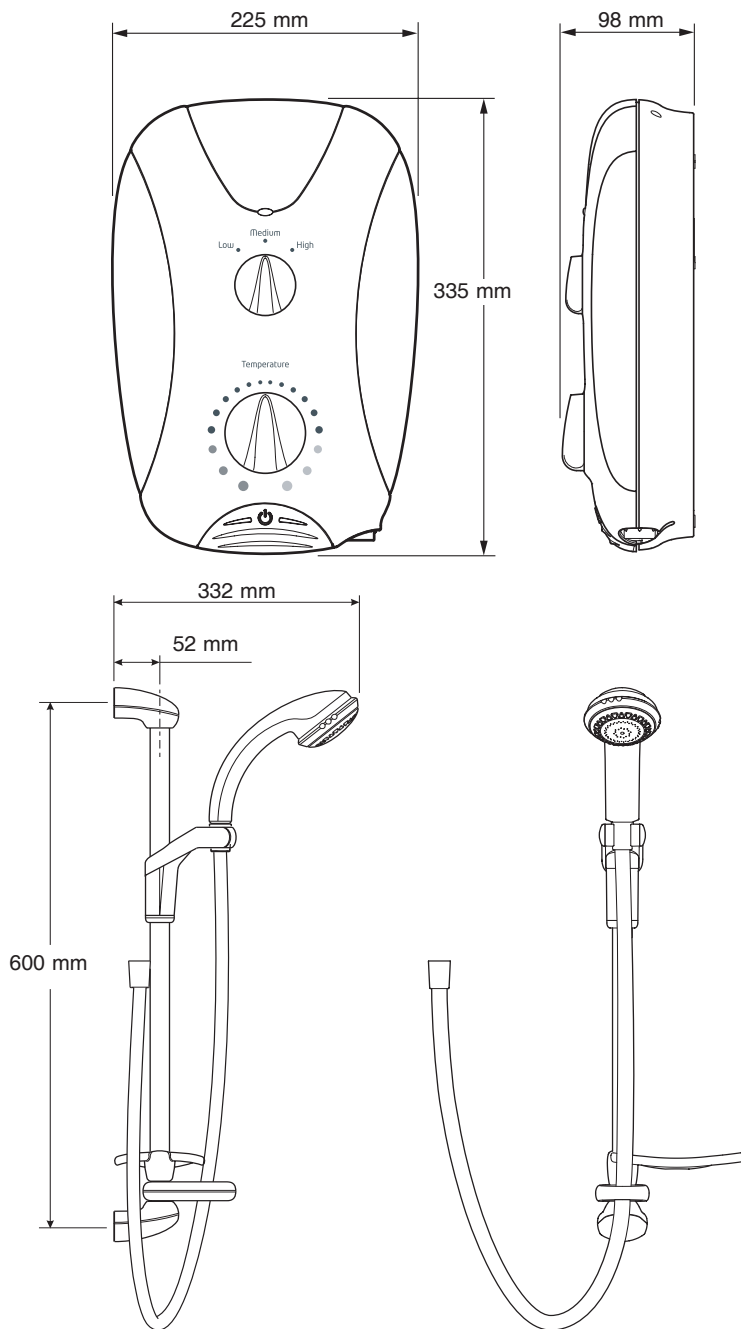

Wiring Diagram

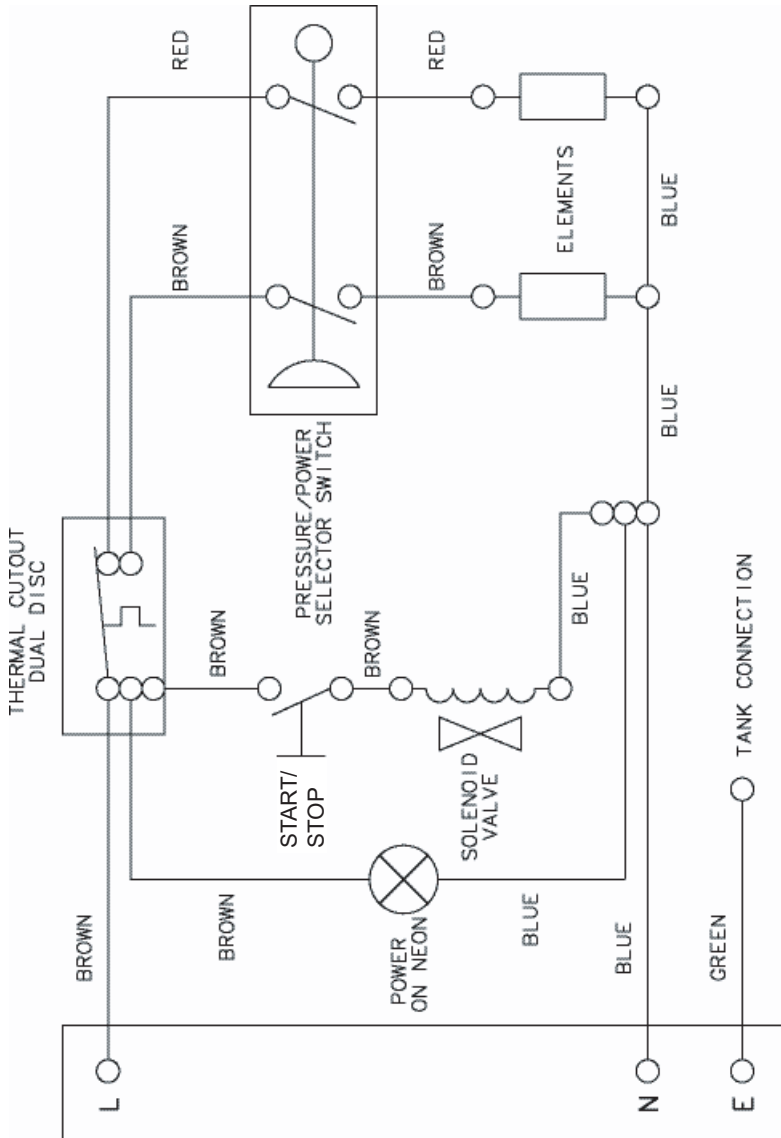

Internal Wiring Diagram

Accessories

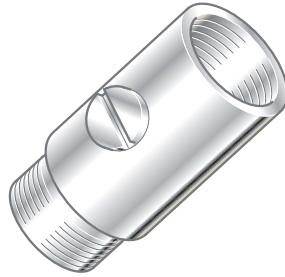

DCV-H: An outlet double check valve, designed to prevent the backflow or backsiphoning of potentially contaminated water, through shower controls which are fitted with a flexible hose as part of the outlet shower fitting. Available as an optional accessory from all Mira Showers stockists.

Spare Parts

Mira Play Spare Parts List (see diagram on next page)

406.27	Inlet filter (with 'O' Seal fitted)
439.75	Inlet Connector Assembly
439.76	Clamp Bracket - components identified "A"
439.88	Seal Pack - components identified "B"
439.89	Screw Pack - components identified "C"
439.90	Thermal Switch
439.93	Heater Tank 9.5 kW
439.99	Outlet Connector and Ball
1539.339	Switch Assembly
1539.340	Neon Assembly (not shown)
1539.341	Cover Assembly - White/White Panel
1539.342	Cover Assembly - Satin/Chrome Panel
1539.343	Service Tunnel - White
1539.344	Service Tunnel - Satin
1539.349	Terminal Block Assembly
1539.350	Flow Regulator Assembly
1539.352	Start/Stop Switch Assembly
1539.355	Cover Assembly - White/Chrome Panel

Mira Play Spare Parts Diagram

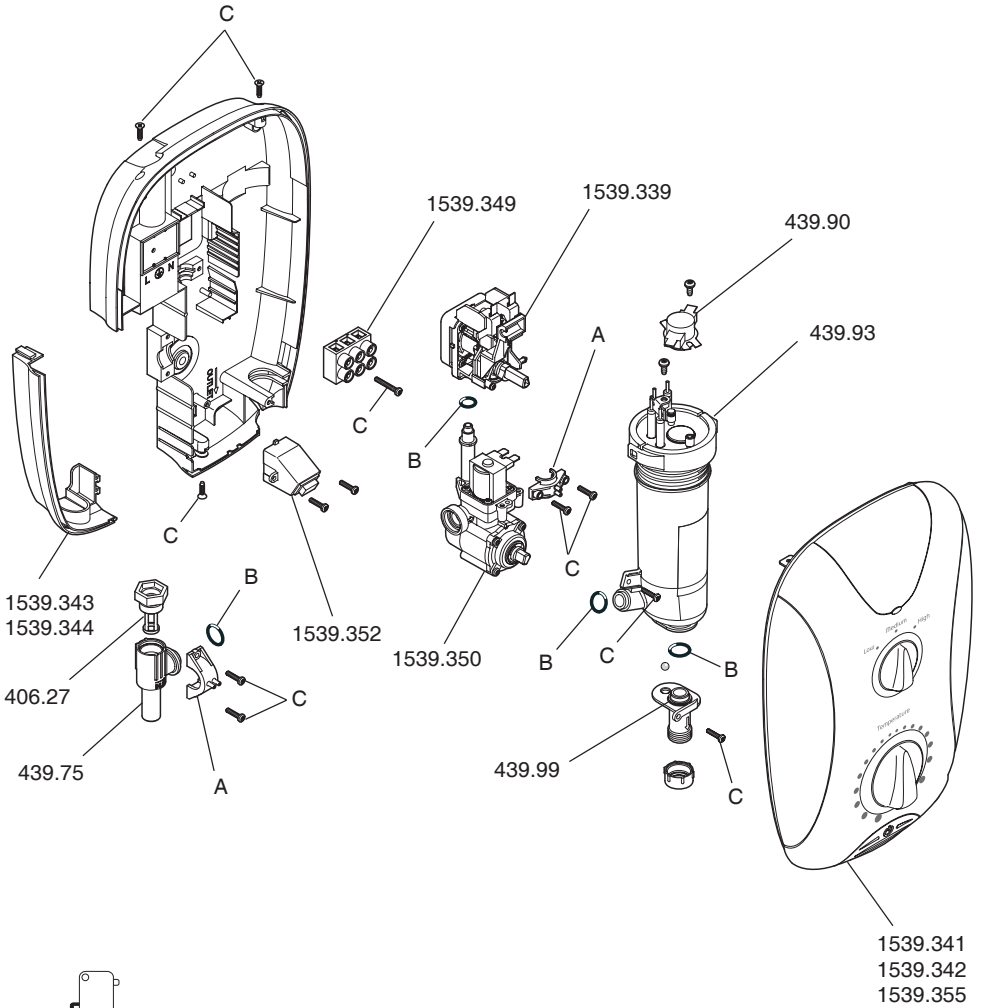

Important Note!

Push-fit connectors must be assembled **back to back** onto terminals of micro-switches.

A minimum air gap of **4 mm** must be maintained between the connectors after assembly.

Mira Response Adjustable Shower Fittings Spares List

150.58	Hose - chrome
411.05	Adjuster Ring
411.23	Clamp Bracket Assembly
411.30	Slide Bar Support Assembly
411.37	Service Pack 'O' Seals - components identified 'A'
411.53	Slide Bar - stainless steel
411.58	Hose Retaining Ring
411.91	Soap Dish Pack
411.92	Adjustable Handset
411.94	Screw Pack
411.96	Spray Plate Assembly - Low capacity
632.73	Hose Washer

Mira Response Adjustable Shower Fittings Spare Parts Diagram

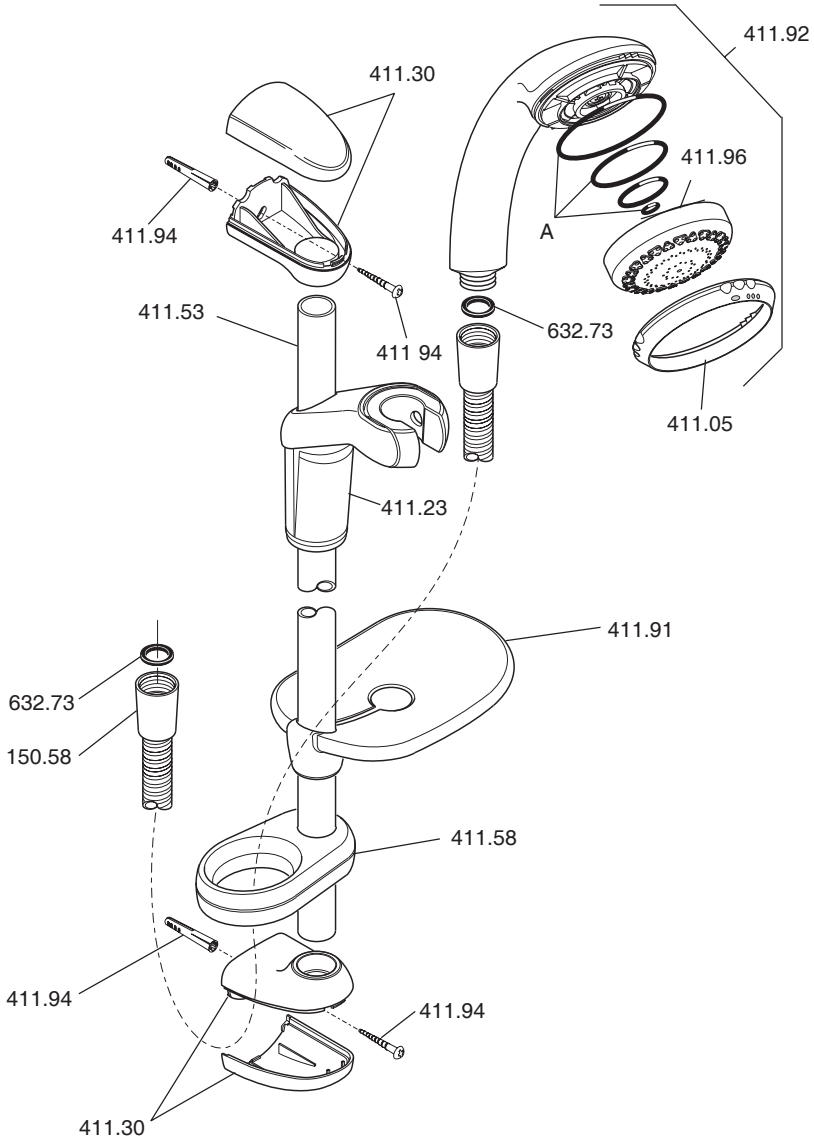

Customer Service

Guarantee of Quality

Mira Showers guarantee your product against any defect in materials or workmanship for the period shown in the Guarantee Registration Document included with your shower.

Alternatively, to confirm the applicable guarantee period please contact Customer Services.

To validate the guarantee, please return your completed registration card.

Within the guarantee period we will resolve defects, free of charge, by repairing or replacing parts or modules as we may choose.

To be free of charge, service work must only be undertaken by Mira Showers or our approved agents in Northern Ireland and Republic of Ireland.

Service under this guarantee does not affect the expiry date. The guarantee on any exchanged parts or product ends when the normal product guarantee period expires.

Not covered by this guarantee:

Damage or defects arising from incorrect installation, improper use or lack of maintenance, including build-up of limescale.

Damage or defects if the product is taken apart, repaired or modified by any person not authorised by Mira Showers or our approved agents.

This guarantee is in addition to your statutory and other legal rights.

Before using your shower

Please take the time to read and understand the operating and safety instructions detailed in this manual.

What to do if something goes wrong

If when you first use your shower it doesn't function correctly, first contact your installer to check that installation and commissioning are satisfactory and in accordance with the instructions in this manual. We are on hand to offer you or your installer any advice you may need.

Should this not resolve the difficulty, simply contact our Customer Services who will give every assistance, and if necessary arrange for our service engineer to visit.

If later the performance of your shower declines, consult this manual to see whether simple home maintenance is required. Please call our Customer Services to talk the difficulty through, request service under guarantee if applicable, or take advantage of our comprehensive After-Sales service.

As part of our quality and training programme calls may be recorded or monitored.

Our Customer Services Team is comprehensively trained to provide every assistance you may need: help and advice, spare parts or a service visit.

Spare Parts

We maintain an extensive stock of spares, and aim to have functional parts available for eight years from the date of final manufacture of the product.

Spares can be purchased from approved stockists or merchants (locations on request) or direct from Customer Services.

Spares direct will normally be despatched within two working days. Payment can be made by Visa or MasterCard at the time of ordering. Should payment by cheque be preferred a pro-forma invoice will be sent.

Note! In the interests of safety, spares requiring exposure to mains voltages can only be sent to competent persons.

Service

Our Service Force is available to provide a quality service at a reasonable cost. You will have the assurance of a Mira trained engineer/agent, genuine Mira spares, and a 12 month guarantee on the repair.

Payment should be made directly to the Service Engineer/Agent, using Visa, MasterCard or a cheque supported by a banker's card.

To Contact us

England, Scotland & Wales

Mira Showers Customer Services

Telephone: 0870 241 0888 - Mon to Fri 8:00 am - 5:30 pm
Sat 9:00 am - 4:00 pm

E-mail: technical@mirashowers.com

Fax: 01242 282595

By Post: Cromwell Road, Cheltenham
Gloucestershire, GL52 5EP

Northern Ireland

Wm H Leech & Son Ltd

Telephone: 028 9044 9257 - Mon to Fri 9:00 am - 5:00 pm

E-mail: leech@dnet.co.uk

Fax: 028 9044 9234

Post: Maryland Industrial Estate
Ballygowan Road, Moneyreagh
Co Down, BT23 6BL

Republic of Ireland

Modern Plant Ltd (Dublin)

Telephone: 01 459 1344 - Mon to Fri 9:00 am - 5:00 pm

E-mail: sales@modernplant.ie

Fax: Dublin 01 459 2329

Post: Otter House, Naas Road
Clondalkin, Dublin 22

Modern Plant Ltd (Cork)

Telephone: 021 496 8755 - Mon to Fri 9:00 am - 5:00 pm

E-mail: cork@modernplant.ie

Fax: 021 496 8607

Post: Tramore Road, Cork

Mira Showers

Kohler Mira Ltd
Cromwell Road,
Cheltenham GL52 5EP.

Mira is a registered trade mark of
Kohler Mira Limited.
The company reserves the right to alter
product specifications without notice.
www.mirashowers.com



FM 14648

mira
SHOWERS