

SEQUENTIAL THERMOSTATIC SHOWER VALVE



OWNER'S GUIDE

ISSUE 02

These instructions cover all exposed or concealed versions of the Sequential Thermostatic Shower Valve Models

INTRODUCTION

This owner's guide shows you how to install, maintain and generally get the most from your sequential thermostatic shower valve.

WE RECOMMEND INSTALLATION BY A QUALIFIED PLUMBER ONLY

TECHNICAL DATA

This shower valve is suitable for use on all common types of plumbing systems including gravity, pumped and fully modulating combination boilers and high pressure unvented systems.

Minimum operating pressure 0.1 bar.

Maximum operating pressure 4 bar.

Important note: At static water pressures above 4 bar, you must install a pressure reducing valve in the mains supply pipe set at 3 bar for optimum results.

As a guide to see if your water pressure is too high simply measure how many pints of water you get from your kitchen tap, with the cold side fully turned on. If you exceed 8 pints (or equivalent) in 30 seconds then you require a pressure reducing valve fitting to your incoming mains supply pipe immediately after stopcock to premises.

TEST DATA

These valves have been pressure tested to 15bar.

Before proceeding, please note:

1. The valve must be installed in compliance with local water authority byelaws and water supply byelaws.
2. Read all the instruction manual before proceeding
3. Only begin the installation when you have all the necessary tools ready.
4. Please check that all the components are in the shower valve box.

AFTERCARE

When installing or using tools, extra care must be taken to avoid damaging the finish or the fitting. To maintain the appearance of this fitting, please ensure it is cleaned regularly using a clean soft damp cloth only. Abrasive cleaners or detergents must not be used as they may cause surface deterioration.

SEQUENTIAL THERMOSTATIC SHOWER VALVES

This shower valve uses a wax thermostatic cartridge to maintain a constant shower temperature. The valve is anti-scald and will automatically shut down the shower if the cold water supply fails. The single sequential control allows the shower to turn on at fully cold, further anti-clockwise movement will gradually blend in the hot water up to a maximum showering temperature of a factory preset 43C when the shower valve is fully opened (this may vary with certain installations).

You must ensure that the temperature of your hot water is at least 60°C for your shower to reach the maximum temperature.

EXPOSED VALVE Contents Check List

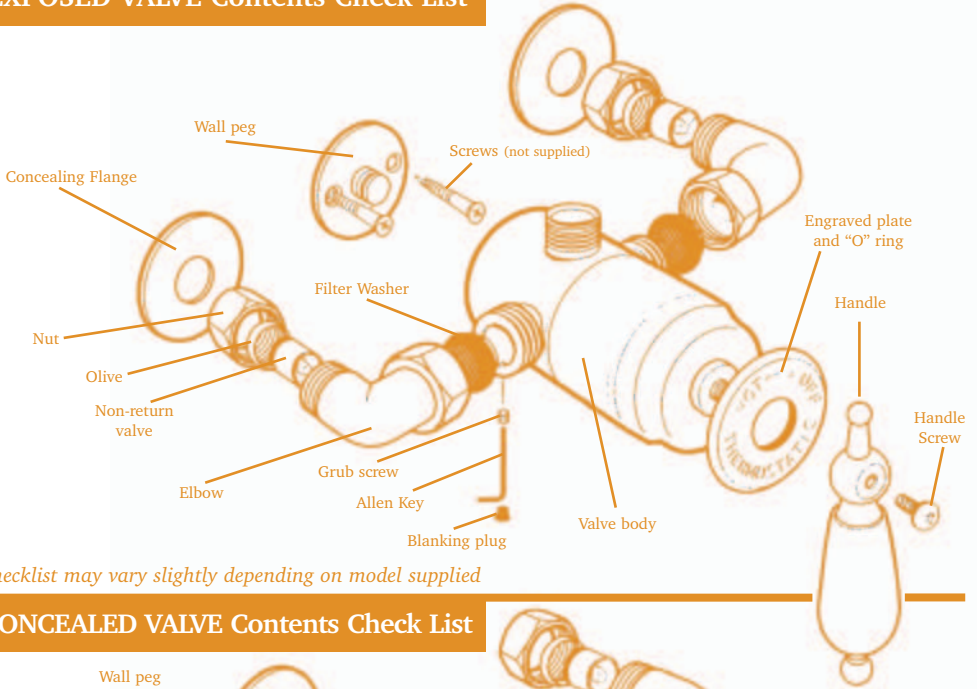

Checklist may vary slightly depending on model supplied

CONCEALED VALVE Contents Check List

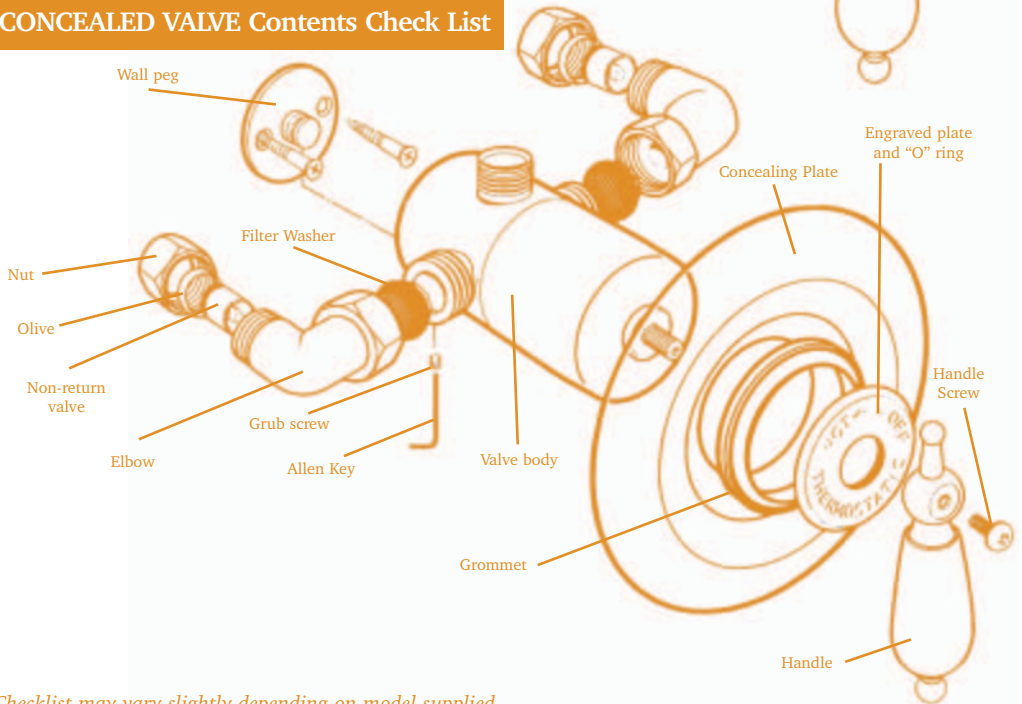

Checklist may vary slightly depending on model supplied

EXPOSED VALVE Dimensions

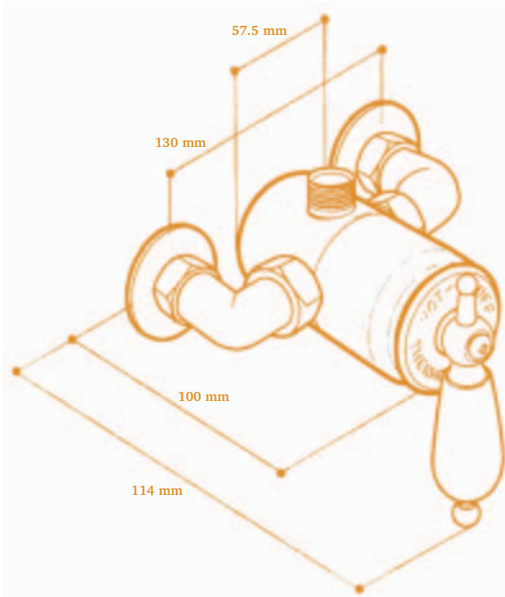

CONCEALED VALVE Dimensions

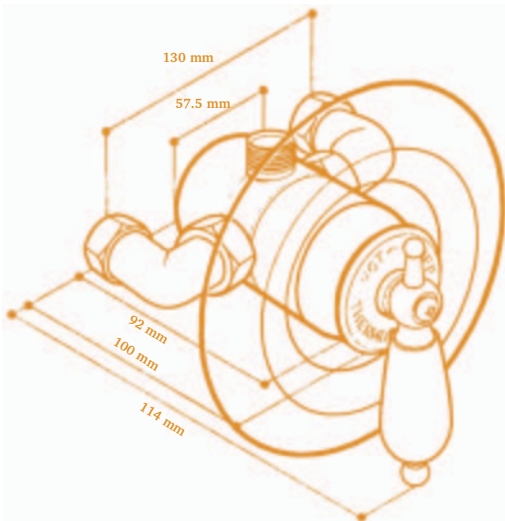

PRE-INSTALLATION NOTES

for EXPOSED and CONCEALED VALVES

- Identify and check all the parts (**shower control handles and concealing plate styles may differ depending on model**).
- When positioning the shower valve, ensure you have sufficient pressure for an acceptable shower.
- The hot water feed must always be connected to the left hand inlet of the shower valve as viewed from the front, with the shower outlet at the top.
- Both hot and cold supply feeds must have accessible isolator valves fitted in-line for servicing purposes (not supplied).
- Refer to plumbing diagrams for further installation guidelines.

INSTALLATION NOTES

ON HOT WATER SYSTEMS

PLUMBING DIAGRAMS

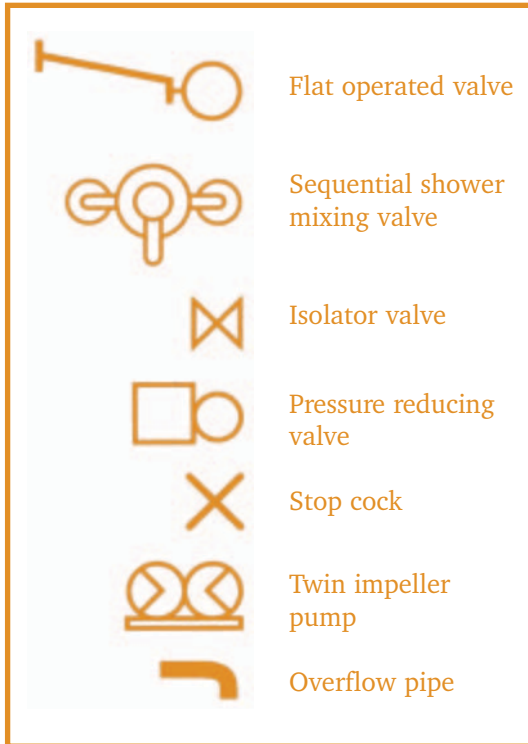

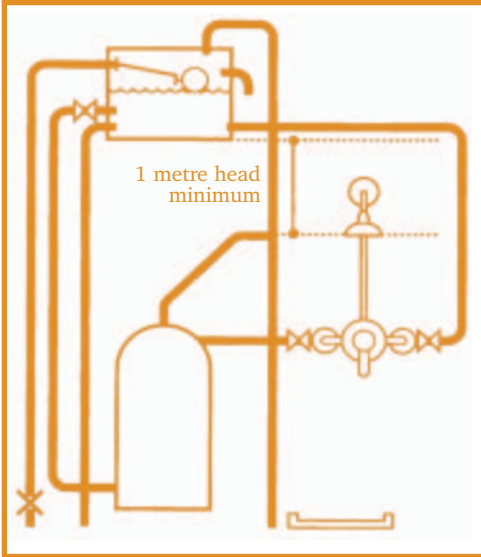

GRAVITY FED SHOWERS

The shower valve **must** be fed from a cold water storage tank and a hot water cylinder. The use of a Surrey or Essex flange connection to the hot water cylinder will ensure an independent supply of hot water to the valve; this action will stop air being drawn into the system.

N.B. Keep all pipework runs as short as possible for maximum shower performance.

N.B. Wherever possible 22mm pipework should be used.

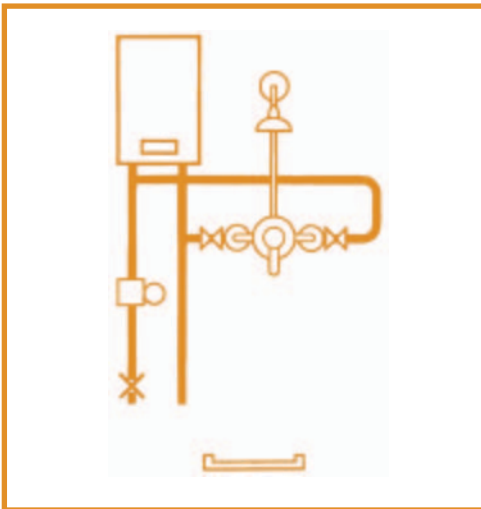

GAS HEATED/COMBI-BOILER SHOWERS

The shower valve must be installed with a modulating type combi-boiler or multi-point gas water heater. This system will produce a constant flow of water within the operating specifications of the appliance.

N.B. The outlet temperature of the system **must** be capable of supplying hot water in **excess of 60°C**.

A pressure reducing valve may be required to ensure that cold water pressures do not exceed 4 Bar static.

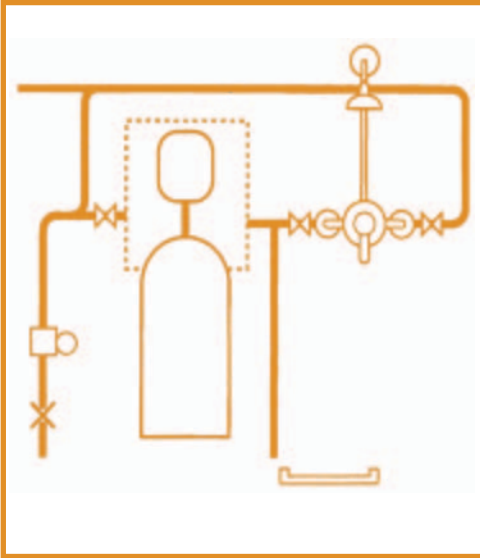

UNVENTED MAINS PRESSURE SHOWERS

The shower valve can be used on an unvented mains pressure system. This type of system **must** only be installed **by a competent person as per the requirement of Part G of Schedule 1 to the building regulations.**

For systems with no cold water take off after the heaters pressure reducing valve, an additional pressure reducing valve must be fitted, and set, at the same pressure as the heaters.

The water supply pressure to the shower valve must be between 1 and 4 Bar.

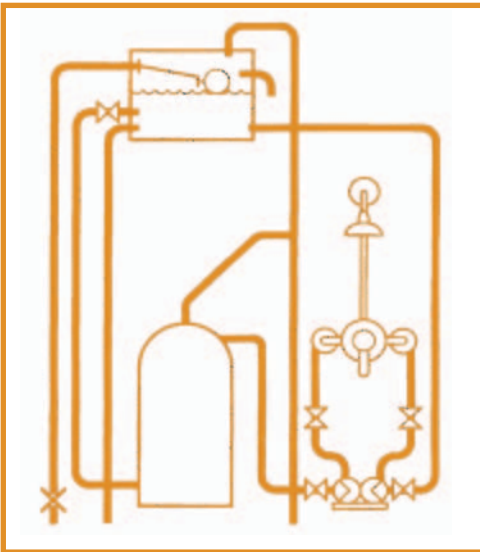

PUMPED SHOWERS

The shower valve can be used on a gravity fed pumped system. The use of a Surrey or Essex flange connection to the hot water cylinder will ensure an independent supply of hot water to the valve; this action will stop air being drawn into the system.

N.B. Please follow pump manufacturers' instructions relating to the sitting and water feed details to the pump. Keep all pipework runs as short as possible for maximum shower performance.

N.B. Wherever possible 22mm pipework should be used.

EXPOSED VALVE Site Preparation

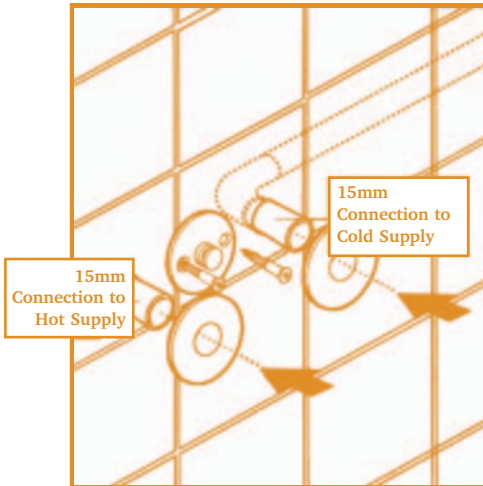

- Ensure hot and cold supply pipe feeds are positioned correctly ready to connect to the shower valve inlet elbows.
- If a rigid riser kit is being used, ensure the valve is positioned correctly to take the height of the vertical pipe.
- Position the wall peg and secure to the wall by means of two suitable screw fixings (not supplied).
- Both hot and cold supply feed must be flushed through before connection to the shower valve is made. Re Water Supply Byelaw 55.
- To create a waterseal, use a thin line of suitable sealant around the supply pipe feeds and the tiles
- Fit the concealing flanges over the supply pipes.

CONCEALED VALVE Site Preparation

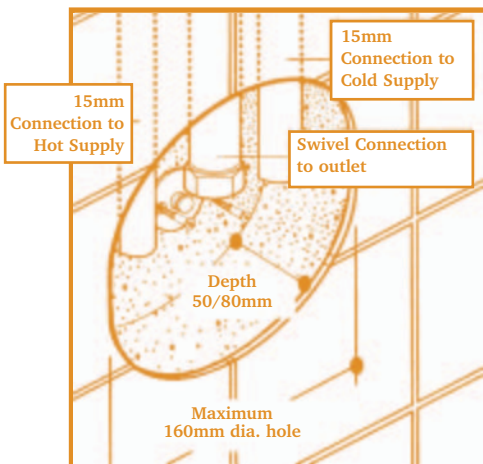

- Make a cavity in the wall to allow the hot and cold water supply connections to be made.
- Position the wall peg and secure in the wall cavity by means of two suitable screw fixings (not supplied)
- Both hot and cold supply feed must be flushed through before connection to the shower valve is made. Re Water Supply Byelaw 55.

EXPOSED VALVE Site Preparation

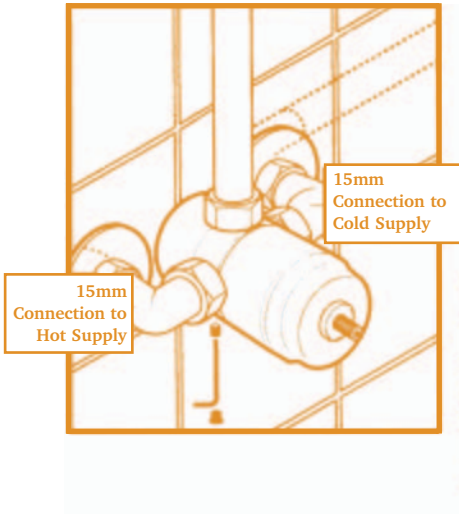

- Connect the hot and cold water supply feeds to the shower valve using swivel connector.
- Fit the shower valve to the wall peg and secure by tightening the grub screw using the Allen key provided. Fit blanking plug.
- Make connection to shower outlet, using swivel connector.
- **Check for any leaks.**

See
Page
11

For use with flexible hose, the sequential thermostatic shower valve should be installed with the connection in the downward position. It must be remembered that the location of the hot and cold water inlets will be reversed. (see illustration left)

CONCEALED VALVE Site Preparation

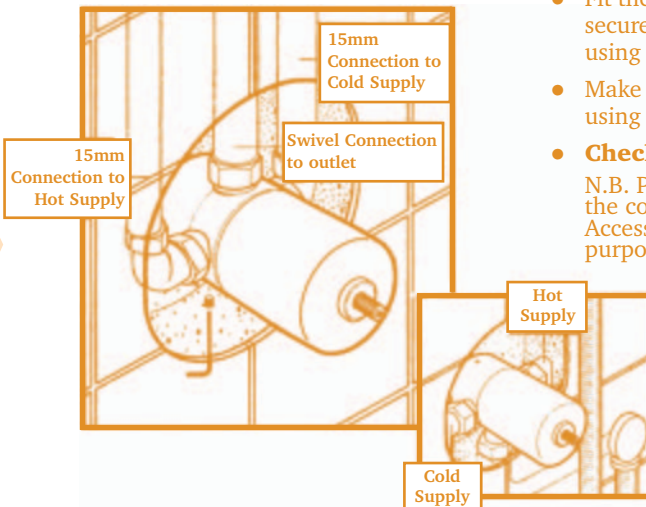

- Connect the hot and cold water supply feeds to the shower valve, using swivel connector.
- Fit the shower valve to the wall peg and secure by tightening the grub screw using the Allen Key provided.
- Make connection to shower outlet, using swivel connection.
- **Check for any leaks.**

N.B. Please ensure that the area around the concealed valve is not filled in. Access must be left for servicing purposes.

See
Page
10

The sequential thermostatic shower valve can be installed with the connection in the downward position. It must be remembered that the location of the hot and cold water inlets will be reversed. (see illustration left)

CONCEALED VALVE Fit Concealing Plate

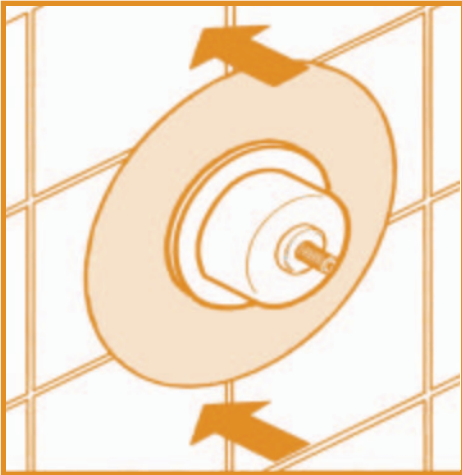

- Place Grommet within the concealing plate centre and push the plate into position

N.B. A mild soapy solution around the inside of the Grommet will ease fitting.

- To create a waterseal, use a thin line of suitable sealant between the concealing plate and the wall.

CONCEALED VALVE Final Assembly

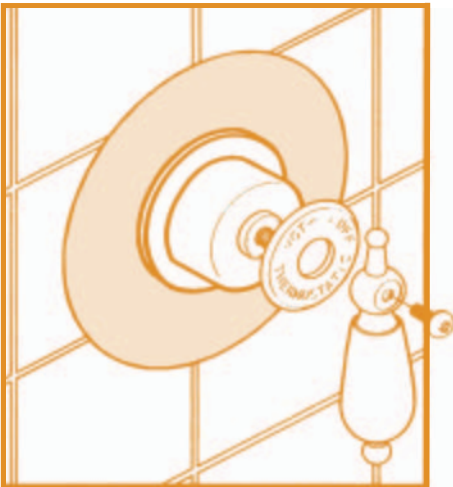

- Fit the engraved plate and position correctly (not included on all models)
- Fit the shower control handle (shower control handle and concealing plate may vary depending on model).
- Check the function of the valve. The maximum temperature should be 43°C; if not, see Fault Finding chart at the back of this guide.

EXPOSED VALVE Final Assembly



(Continued from page 9)

- Fit the engraved plate and position correctly (not included on all models).
- Fit the shower control handle (Style may vary depending on model).
- Check the function of the valve. The maximum temperature should be 43°C; if not, see Fault finding chart at the back of this guide.

TEMPERATURE ADJUSTMENT

The maximum temperature of the shower valve has been factory pre-set at 43°C, if for any reason you wish to adjust the maximum temperature, please follow these instructions:

TO INCREASE THE PRESET TEMPERATURE

- Set the shower to the hottest setting (anti-clockwise)
- Ensure the shower is running
- Remove the handle
- Locate the Allen key down the spindle
- The Allen key will locate onto a grub screw
- To increase the temperature turn the Allen key $\frac{1}{4}$ of a turn anticlockwise, leave for 10 seconds to allow temperature to stabilise
- Repeat the process if the temperature is not sufficient. Note, the Allen key should not go through more than 2 full turns or 8 x _ turn increments
- If the shower valve does not get up to a minimum of 43°C, this suggests a problem with the incoming cold supply pressure. Please refer to Fault Finding Chart.



TO DECREASE THE PRESET TEMPERATURE

- To decrease the temperature, carry out the same procedure but with a clockwise action

FAULT FINDING CHART

GRAVITY or PUMPED SYSTEM	
FAULT	DIAGNOSIS
<i>“Showering temperature is not hot enough”</i>	<ul style="list-style-type: none"> ● Ensure hot water supply is at least 60°C ● Make sure you have equal pressures ● Check for airlocks in pipework ● Ensure there are no inverted ‘U’s in any of the pipework runs ● Refer to temperature adjustment section on page 11
<i>“Water goes cold during shower”</i>	<ul style="list-style-type: none"> ● Insufficient hot water storage
<i>“When shower is set at cold, the showering temperature is too hot”</i>	<ul style="list-style-type: none"> ● Hot and cold supply connections have been made in reverse – reconnect correctly
<i>“Shower temperature is too hot” (pumped shower)</i>	<ul style="list-style-type: none"> ● Turn down the flow of hot water from the pump using the in-line isolator valve. Refer to temperature adjustment section on page 11.

COMBI or OTHER HIGH PRESSURE SYSTEM	
FAULT	DIAGNOSIS
<i>“Showering temperature is not hot enough”</i>	<ul style="list-style-type: none"> ● Incoming mains pressure exceeds 4 Bar – ensure you have fitted a pressure reducing valve in the mains supply pipe ● Ensure hot water supply is at least 60°C ● Refer to temperature adjustment section on page 11
<i>“Valve is very noisy when in use”</i>	<ul style="list-style-type: none"> ● Incoming mains pressure exceeds 4 Bar – ensure you have fitted a pressure reducing valve in the mains supply pipe immediately after stopcock to premises.
<i>“The water goes cold whilst showering”</i>	<ul style="list-style-type: none"> ● Ensure the boiler is still firing. Adjust the boiler to the hottest output, not the best flow.
<p>NB: Any product guarantees will be invalidated if the internal workings of the valve have been tampered with in any way. Please call out HELPLINE if you are having difficulties.</p>	

**If the Fault Finding chart does not remedy the problem,
please contact the helpline immediately.
Telephone +44 (0)1282 428337**